

METABOLISM OF PLANT TERPENOIDS

GEORGE R. WALLER

*Department of Biochemistry, Agricultural Experimental Station,
Oklahoma State University, Stillwater, Oklahoma 74074, U.S.A.*

I. INTRODUCTION

THE number of terpenoids that are synthesized by plants is probably larger than any other group of naturally occurring compounds. Plants have the ability to produce almost an endless number of chemical variations on a single chemical structure, the *isoprenoid unit*. This group includes essential oils and resins, steroids, carotenoids, and rubber. In most of these compounds, two or more isoprene units are joined together in a head-to-tail linkage^{335, 336, 405} of the carbon atoms, either in open chain or in cyclic systems containing one or more rings (Fig. 1). The main exceptions to the head-to-tail linkage involves the formation

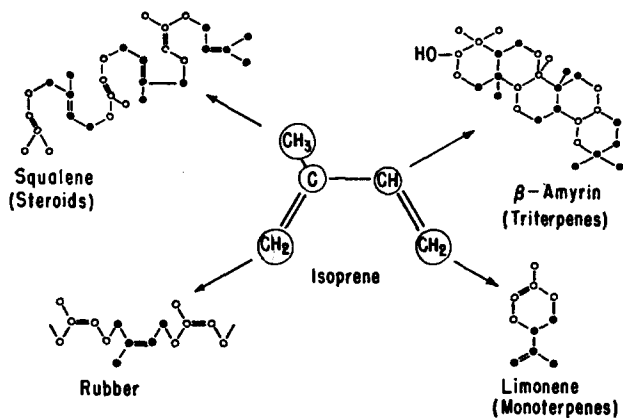

FIG. 1. Structural relationships of the isoprenoids (from ref. 73).

of artemisia ketone (and related monoterpenoids), squalene, gossypol, and the carotenoids. In addition to the unsaturated hydrocarbons which are multiples of C₅H₈, a wide variety of compounds which are derived from them by oxidation, reduction, and/or loss of a carbon atom are found in nature. The wide

diversity of chemically altered structures to which any particular isoprenoid may give rise provides us with many excellent examples why nature is still the most versatile and accomplished chemist.

A summary of the general classes of terpenoids is shown in Table 1.⁷³ More specific information on the structure and distribution of terpenoids can be found in the reviews by Sandermann³⁴⁸ and Weissman.⁴¹¹ It appears that all plants possess the ability to synthesize several members of the isoprenoid family,⁷⁸ but in many species this may be restricted to carotenoids, phytol (the chlorophyll side-chain), and the steroids. In contrast, the ability to form mono-, sesqui-, di-, tri-, and polyterpenes and their derivatives is scattered irregularly

TABLE 1†
The Isoprenoid Family

Class	Empirical formula	Occurrence and example	Oxygenated derivatives
Isoprene Monoterpenes	C ₅ H ₈ C ₁₀ H ₁₆	Does not occur in nature Essential oils, myrcene	Isopentenol pyrophosphate Terpene alcohols (geraniol), aldehydes, ketones
Sesquiterpenes Diterpenes	C ₁₅ H ₂₄ C ₂₀ H ₃₂	Essential oils, resins, farnesene Essential oils, resins, C ₂₀ terpene	Alcohols (farnesol), ketones C ₂₀ terpenol, phytol, vitamin A, resin acids
Triterpenes	C ₃₀ H ₄₈	Ubiquitous, squalene	Sterols (<C ₃₀), saponins, lupeol
Tetraterpenes Polyterpenes	C ₄₀ H ₆₄ (C ₅ H ₈) _n	Carotenes, phytoene Rubber, gutta	Xanthophylls Alcohols (polyprenols)

† From ref. 73.

throughout the plant kingdom. This review will deal with the biosynthesis and breakdown of the relatively few plant-produced terpenoids on which studies have been made. Sandermann³⁴⁴ reviewed this subject in 1962. Nicholas²⁸² reviewed the biosynthesis of terpenoids in 1963, as did Clayton¹¹² in 1965. Richards and Hendrickson thoroughly covered the biosynthesis in their book published in 1964.³²³ Many important observations in the field were published in the proceedings from a Ciba Foundation Symposium in 1959.⁴²³ The reader is urged to consult these reviews for many historical details. Nicholas²⁸⁴ has recently reviewed the metabolism of isoprenoid compounds and has covered animal-produced terpenoids and the higher molecular weight terpenoids quite effectively.

The researches conducted on cholesterol biosynthesis by the laboratories of Bloch, Cornforth and Popják, and Lynen have helped clarify many of the steps involved. This information can be extended to terpenoids in general, and particularly to the steps leading to the formation of farnesylpyrophosphate from acetate.

II. BIOSYNTHESIS†

A. Generation of the biological isoprene unit

The very structure of terpenes makes it seem probable that they are generated from a basic five-carbon unit as suggested by Ruzicka in 1953.³³⁵ Bloch and Rittenberg⁶⁸ were the first to demonstrate that the carbon skeleton of a polyisoprenoid compound, cholesterol, arose exclusively from acetate (I). An extensive search for the intermediates in the pathway led to the testing of various five- and six-carbon branched chain acids as precursors. A major development in elucidating the biosynthetic pathway of polyisoprenoid compounds came from the discovery of mevalonic acid (MVA) (XI) by Folkers and his associates^{153, 361} at Merck, Sharp and Dohme laboratories. The similarity of this compound to 3-hydroxy-3-methyl-glutaric acid (HMG) (V), a compound which Bloch had shown to be a precursor, made it seem like a probable candidate. Experiments

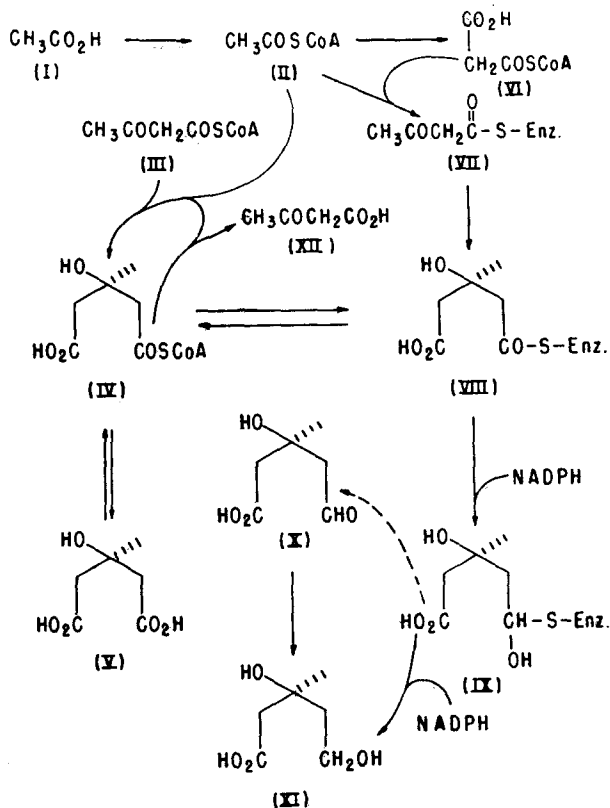

FIG. 2. Biosynthesis of mevalonic acid from acetic acid.

† The suggestion of F. R. Stermitz and H. Rapoport, *J. Am. Chem. Soc.* **83**, 4045 (1961), that the word "biosynthesis" should describe *in vivo* experimental studies on the mode of formation of natural products while the word "biogenesis" should be applied to the hypothetical schemes suggested to rationalize the formation and structures of natural products will be followed.

with rat liver homogenates showed that 43 per cent of racemic MVA-2-¹⁴C could be converted to cholesterol while the radioactivity of MVA-1-¹⁴C was lost as ¹⁴CO₂.^{174, 378, 379} These observations indicated that the six-carbon MVA (XI) became the five-carbon isoprenoid precursor by the loss of the carboxyl group at C-1 and that only one enantiomorph of racemic MVA was converted to cholesterol. The basic isoprene unit was ultimately found to be isopentenyl-pyrophosphate (IpPP) and was shown to be generated through phosphorylated derivatives of MVA (XI) as indicated in Fig. 4.^{67, 108, 257}

1. Formation of mevalonic acid (XI)

Most of what is known concerning the biosynthesis of MVA (XI) has been obtained using yeast and liver systems, and Popják and Cornforth have discussed this subject in detail.³⁰¹ At the present time, it is not clear whether the formation of MVA (XI) occurs through free acetoacetyl-CoA (III) and hydroxymethyl-glutaryl-CoA (HMG-CoA) (IV) or if these acids are protein bound at all times until the release of MVA (XI).

All of the reactions for the synthesis of MVA (XI) from the coenzyme A esters of acetoacetate (III) and HMG (IV) have been demonstrated.^{81, 260, 331, 332} The formation of HMG-CoA (IV) from acetoacetyl-CoA (III) and acetyl-CoA (II) is mediated by the condensing enzyme and has been reported in both liver and yeast^{260, 332} and in plants.²¹⁷ Equimolar quantities of acetoacetyl-CoA (III) and acetyl-CoA (II) are consumed in the reaction with the formation of HMG-CoA (IV) and the release of coenzyme A from acetyl-CoA (II).³³³ The acyl thiol bond of the reacting acetoacetyl moiety remains intact during the reaction. In yeast systems the enzyme is located in the soluble fraction while it is located in both the microsomes and mitochondria of rat liver systems.⁸⁶ The net contribution to MVA synthesis by the mitochondrial condensing enzyme is probably small since it is coupled with an enzyme which cleaves HMG-CoA as indicated in Fig. 1. The net effect of these two enzymes is the conversion of acetoacetyl-CoA (III) and acetyl-CoA (II) to acetyl-CoA (II) and acetoacetic acid (XII).

Hydroxymethylglutaric acid (V) is probably not a direct intermediate in the formation of MVA (XI) from acetate (I). Metabolism of this acid, however, has been demonstrated in both animals and plants.^{130, 223}

Reduction of HMG-CoA (IV) to MVA (XI) is catalyzed by a single enzyme, hydroxymethyl-glutaryl-CoA reductase.¹⁴⁰ Reduction occurs at the thiol ester linkage and requires two moles of NADPH. It is generally concluded that free mevaldic acid (X) is not an intermediate in the reaction. The reduction of HMG-CoA (IV) to MVA (XI) is reversible with difficulty, which explains the efficient utilization of MVA for sterol synthesis which is in contrast to the poor utilization of HMG-CoA. It was suggested that the small amount of mevaldate (X) in the avian liver preparations is due to the non-enzymatic hydrolysis of the protein-bound intermediate indicated in Fig. 1. The presence of mevaldate reductase in the mammalian liver systems reported by several groups^{116, 153, 226, 255, 353, 426} has been suggested to be a salvage enzyme for the mevaldic acid (X) formed in this hydrolysis. Severe depression of HMG-CoA

reductase activity in fasting rats suggests that this enzyme may play an important role in the control of the formation of isoprenoid compounds.

An alternate pathway for the biosynthesis of MVA (XI) has been reported.^{82, 83, 84} The purified fatty acid synthesizing system from pigeon liver extracts catalyzed the formation of HMG-CoA (IV) and MVA (XI) from acetyl (II) and malonyl-CoA (VI) when deprived of NADPH. Trapping experiments proved conclusively that acetoacetyl-CoA (III) and HMG-CoA (IV) were not obligatory intermediates. The acetate and malonate moieties of acetyl- and malonyl-CoA were independently bound to protein through thioester bonds. Acetoacetate could be isolated from the protein after treatment with strong base, indicating that it was also protein bound. It has been proposed that the intermediates are all enzyme bound until the final release of MVA (XI).

The interesting observation has recently been made that the condensing enzyme from yeast will accept acetoacetyl-acyl carrier protein from *E. coli* as well as acetoacetyl-CoA (XIII).³³⁰ The probable product of this reaction is HMG-acyl carrier protein (XIII) as indicated in Fig. 2. The thiol ester bond of the acetoacetyl moiety remains intact during the reaction. It may be speculated that acyl carrier protein is of some significance in isoprenoid biosynthesis.

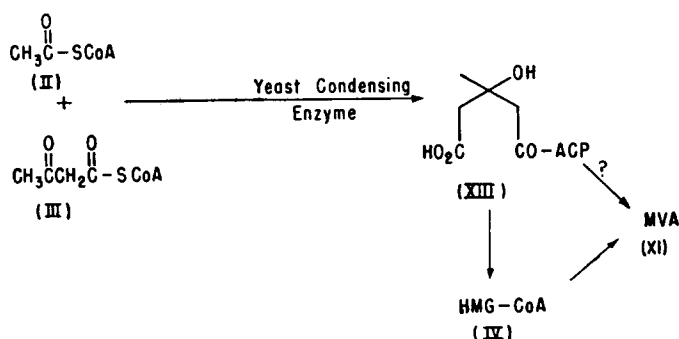

FIG. 3. Formation of HMG-acyl carrier protein.

2. Synthesis of isopentenylpyrophosphate

Since mevalonic acid supplies five of its six carbons to the isoprenoid pathway, it was of considerable importance to establish the most biologically active isoprene unit. The incorporation of MVA into squalene by a dialyzed yeast enzyme system required the addition of ATP and pyridine nucleotides.⁹ This finding suggested the possible existence of a phosphorylated intermediate being required in terpenoid biosynthesis.

Mevalonic acid is converted to Δ^3 -isopentenylpyrophosphate (IpPP) (XVI) in three ATP dependent steps (Fig. 4). The first reactions are catalyzed by mevalonate kinase^{241, 247, 381} and mevalonate phosphate kinase,^{67, 202} resulting in mevalonate-5-phosphate (XIV) and mevalonate-5-pyrophosphate (XV), respectively. The third reaction to form IpPP (XVI)¹⁰⁸ is a rather unique decarboxylation which appears to be initiated by phosphorylation at the hydroxyl group to provide a triphosphorylated MVA (XVII) intermediate.^{67, 258}

The presence of mevalonate kinase and mevalonate phosphate kinase has been demonstrated in both yeast and mammalian systems^{300, 381} and the former also in higher plants^{247, 421} and bacteria.¹¹⁷ These enzymes are stereospecific for the (+)-isomers of mevalonic acid (XI) and mevalonate-5-phosphate (XIV), respectively, and require ATP.^{134, 257} Differences in these two kinases are found in that the mevalonate kinase catalyzed reaction is irreversible while that of mevalonate phosphate kinase may be reversed with an excess of ADP. Divalent metal ion requirements and pH optima near 7.0 are exhibited by these enzymes.

The enzymatic conversion of mevalonate-5-pyrophosphate (XV) to IpPP (XVI) by the mevalonate-pyrophosphate decarboxylating enzyme is ATP dependent and has also been demonstrated in both yeast and mammalian systems. Products of the dehydration-decarboxylation reaction are IpPP (XVI), CO₂, ADP, and inorganic phosphate, and a stoichiometric relation between the substrates and products is observed.⁶⁷ Isolated needles and cell-free extracts of *Pinus radiata* incorporate radioactive inorganic phosphate into ATP, mevalonate-5-pyro-

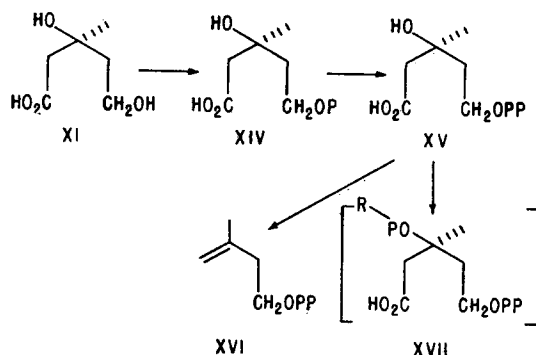

FIG. 4. Formation of isopentenylpyrophosphate from mevalonic acid.

phosphate (XV), and IpPP (XVI); and MVA-2-¹⁴C into XIV, XV, and XVI.³⁹⁷ Studies with mevalonate-3-¹⁸O²⁴² indicate that an ester linkage is formed between the terminal phosphate at ATP and the tertiary hydroxyl group of mevalonate-5-pyrophosphate (XV). Since all attempts to isolate this phosphate ester have failed,^{67, 397} the ester either decarboxylates while it is still on the enzyme or undergoes β -elimination spontaneously after release from the enzyme. Alternatively, since a mevalonic acid-3-phosphate derivative has not been found as an intermediate, the mechanism most consistent with the facts is a concerted elimination³⁰² (XV \rightarrow XVI).

B. Isomerization and polymerization of the biological isoprene unit

Lynen *et al.*²⁵⁷ found that part of the IpPP (XVI) must isomerize to produce an allylic pyrophosphate in the form of dimethylallylpyrophosphate (DmaPP) (XVIII) before polymerization to geranylpyrophosphate (XIX) (GPP) and higher isoprenoids can occur. This conversion is catalyzed by isopentenylpyro-

phosphate isomerase.⁴ The isomerase is inhibited by iodoacetamide and the equilibrium ratio of IpPP and DmaPP is 87:13.³⁵⁸

The mechanism of isomerization, first proposed by Agranoff *et al.*,⁴ and later established by Shah *et al.*,³⁵⁸ involves the stereospecific addition and removal of a proton at carbon atom 2 (Fig. 5). An enzyme-substrate complex has been isolated³⁵⁸ in which the intermediate (Fig. 5) is proposed to be bound covalently to a sulfhydryl group of the isomerase.† In this mechanism, the methylene carbon atom of IpPP (XVI) is protonated, the proton from carbon atom 2 is

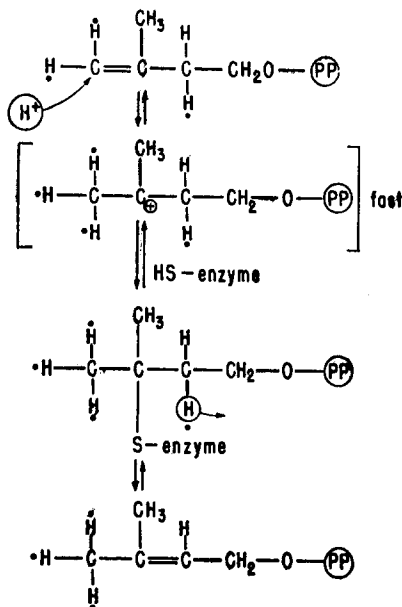
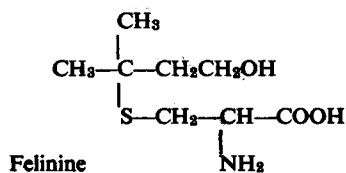

FIG. 5. Mechanism of isomerization of isopentenylpyrophosphate. The starred atoms indicate the exchangeable hydrogens of isopentenyl and dimethylallylpyrophosphates (according to Shah *et al.*³⁵⁸).

discharged into the medium, and DmaPP (XVIII) is formed. In the reverse reaction, a proton is added stereospecifically at carbon atom 2 of DmaPP (XVIII). Consequently, this isomerization does not result in a randomization of the label originally present in the methylene group of IpPP (XVI).

The condensation of one mole of IpPP and one mole of DmaPP yields geranylpyrophosphate (XX) (GPP) or methylerythritylpyrophosphate with the elimination of

† An interesting substance that may be related to the S-enzyme intermediate is felinine, an unusual amino acid excreted in cats' urine, which may be formed from MVA or leucine. (P. V. Arigoni and J. C. Wriston, *Biochem. Biophys. Acta* 34, 279 (1959).)



pyrophosphate and a proton (H^+) from one of the C_5 precursors.^{73, 112, 323, 423} The elimination of the proton is probably stereospecific with respect to carbon atom 2 of IpPP. The methyl groups in the DmaPP thus seem to retain their identity by being either *cis* or *trans* with respect to the double bond and support the mechanism described in the preceding paragraph. Biosynthesis studies indicate that the methylene group of IpPP (XVIa) becomes the *trans* methyl

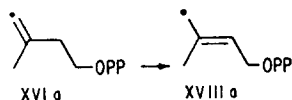

group in DmaPP (XVIIIa). This phenomenon will be discussed later in relation to biosynthesis studies performed on specific compounds.

The formation of sesquiterpenes, diterpenes, and higher isoprenoids occurs by the condensation of a mole of IpPP with GPP, farnesylpyrophosphate (XX) (FPP), geranylgeranylpyrophosphate (XXI) (GGPP), etc., in a "head-to-tail" type reaction as shown in Fig. 6.

In yeast and liver, FPP (XX) is enzymically produced in this manner from GPP (XIX).^{119, 300, 301} In the pea plant enzyme extract, GPP (XIX), FPP (XX), and GGPP (XXI) are sequentially produced.²⁹⁸ Thus, further polymerization

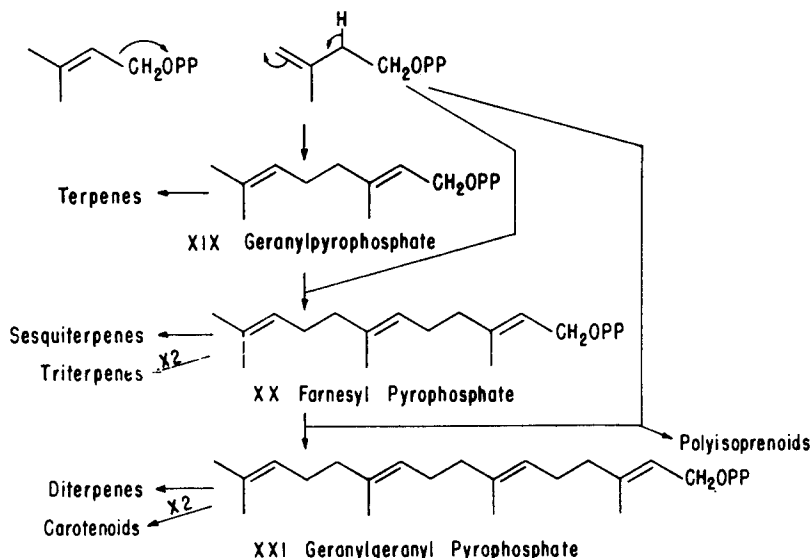

FIG. 6. Biosynthesis of polyisoprenoid units employing the "head-to-tail" type reaction.

(i.e., in the production of rubber) may be considered to occur in an analogous fashion to the formation of these terpenolpyrophosphates. Alternatively, as will be discussed later, further polymerization can occur by the condensation of higher isoprenoid homologues (i.e., 2 moles of FPP (XX) to give squalene).

The enzymatic synthesis of *trans*-GGPP (XXI) from IpPP (XVI) and *trans*-

FPP (XX) by an enzyme system from bakers' yeast,¹⁸¹ a partially purified carrot root GGPP synthetase²⁷⁶ preparation and a partially purified synthetase from *Micrococcus lysodektius*²²¹ has been reported. The yeast enzymes also catalyzed the formation of FPP, but the conversion of FPP to GGPP was 150 times slower than FPP synthesis under the same conditions. Mg^{++} is required for the yeast and bacterial enzymes, but Mn^{++} is a better activator for the carrot root (and also pig liver) enzyme(s).

The formation of *trans*-geranylgeraniol from MVA in the presence of ATP was demonstrated in cell-free homogenates of the endosperm nucellus of the seed of *Echinocystis macrocarpa* (wild cucumber).¹⁷⁵ Presumably, the formation of the C_{20} terpenol proceeded through its pyrophosphate, although the latter was not isolated. Most likely, the geranylgeraniol resulted from the action of phosphatase on GGPP. It still remains uncertain as to whether one or several enzymes are involved in the biosynthesis of GGPP from IpPP and the three allylpyrophosphates (DmaPP, GPP, and FPP).

C. Monoterpenoids

1. Open-chain compounds

i. *Head-to-tail monoterpenoids*. Most of the monoterpenes (C_{10}) and their related alcohols, aldehydes, or ketones can be derived from geraniol (XXII) or nerol (XXIII). Geraniol can be formed by the action of pyrophosphatase on GPP (XIX).† It is logical that the myriad of C_{10} hydrocarbons (see ref. 343 for more structures) such as myrcene (XXVIII) and the ocimenes (XXIX–XXXI) are formed by dehydration of geraniol; however, experimental evidence to

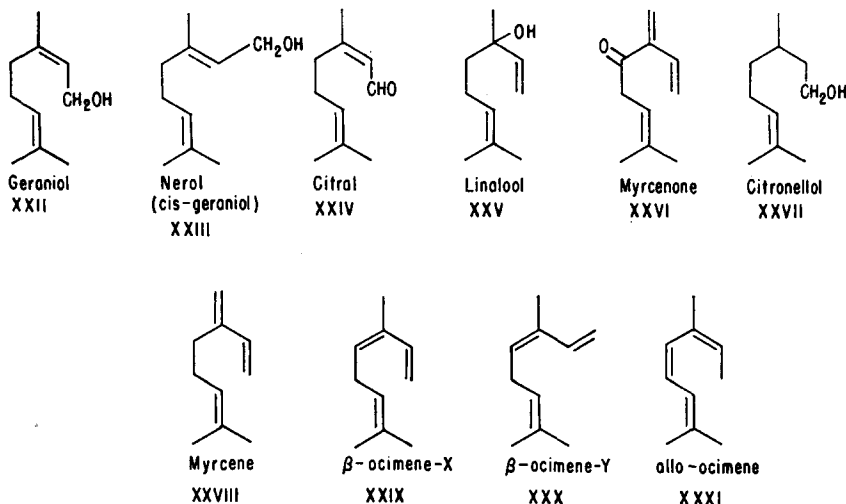

† Unpublished results obtained in our laboratory on *in vitro* studies using *Nepeta cataria* L., *Santolina chaemyocypris* L., and *Skytanthus acutus* M. plant extracts with GPP (XIX) and nerolpyrophosphate as substrates indicate that a rapid conversion to the corresponding alcohols occurs.

support this concept is lacking.† Since alcohol dehydrogenases are widespread in nature, and in general do not exhibit a high degree of substrate specificity, the corresponding C₁₀ aldehyde (citral, XXIV) probably results from such a geraniol oxidation. Analogies for allylic rearrangements to form compounds such as linalool (XXV) are not as readily apparent. Formation of secondary C₁₀ alcohols seems, for the most part, to be followed by subsequent oxidation to give rise to the ketones such as myrcenone (XXVI), since the ketones are usually in the highest concentration. Hydrogenation can occur to give the corresponding products such as citronellol (XXVII) from geraniol (XXII).

A recent report⁴⁰⁸ on the phosphorylation in a cell-free system of geraniol (XXII), nerol (XXIII), and dimethylallyl alcohol to the corresponding mono-phosphates is of interest. Leaves of *Mentha piperita* (peppermint), glandular hairs of *Humulus lupulus* (hops), underground and developing inflorescences of *Petasites speciosa* (Western coltsfoot), and germinating seeds of *Pisum sativum* (pea) were used in preparing the extracts. It was difficult to measure total phosphorylation since the extracts also contained an active phosphatase; however, the net phosphorylation of geraniol was 0.5 to 1.0 per cent in 3 hours. ATP was required and Mn⁺⁺ was stimulatory. The phenolic compounds (i.e., tannins) present in plants which tend to bind with enzymes to render them inactive²⁴⁸ were removed by adding insoluble polyvinylpyrrolidone. Phosphorylated intermediates produced by *Pinus radiata* have also been demonstrated.^{398a}

Birch *et al.*⁶¹ demonstrated that acetate-2-¹⁴C can be incorporated into citronellal (XXXII) produced by *Eucalyptus citriodora* (Hook) with labeling of alternate carbons in the chain and of all the methyl carbons. The extent of

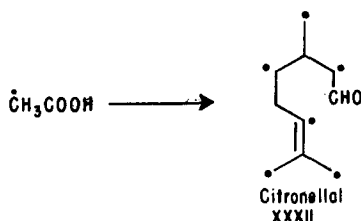

incorporation of radioactivity from the acetate was low. The authors noted that considerable randomization of carbon-14 from acetate-2-¹⁴C had occurred, giving rise to activity in positions that could be derived from the carboxyl carbon of acetate. Convincing evidence for the role of acetate and mevalonate and for the stereospecificity of the methyl groups of the latter compound was obtained by Birch *et al.*⁶⁴ in studies on the biosynthesis of mycelianamide (XXXIII), a metabolite produced by *Penicillium griseofulvum*. The side chain of mycelianamide is methylgeraniolene (XXXIV). Chemical degradation of mycelianamide provided methylgeraniolene, which was fed to a rabbit that formed Hildebrandt's acid (XXXV) (excreted in the urine). Degradation of Hildebrandt's acid to give acetaldehyde (XXXVI) indicated that 80 per cent of the radioactivity of the

† Unpublished results from our laboratory show that dehydration of geraniol readily occurs at temperatures above 150°C in the injection port of the gas chromatograph to give myrcene, ocimene(s), and some unidentified monoterpene hydrocarbons.

terminal methyl groups was not randomized (Fig. 7). The authors suggested that the degree of randomization was more likely a result of the chemical degradative procedure than a lack of specificity during biosynthesis.† These data provided the first strong experimental evidence in support of the mechanism of isomerization of isopentenylpyrophosphate discussed in the preceding section of the chapter.

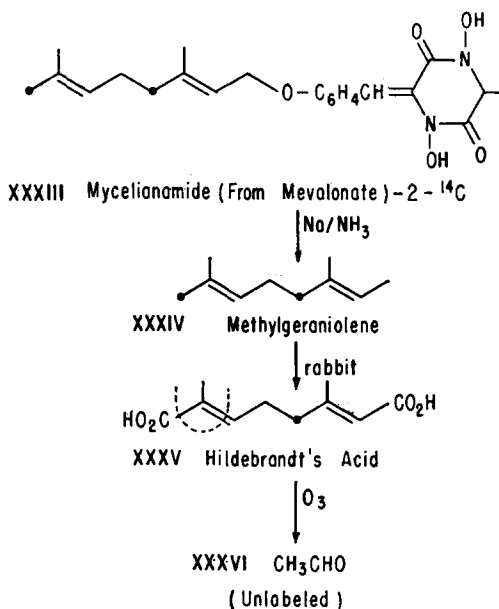

Fig. 7. Proof of steric differentiation in the terminal methyl groups of geraniol synthesized from mevalonate-2-¹⁴C.⁶⁴

It is of interest to note that citronellal (XXXII) and citral (XXIV) biosynthesis from acetate and mevalonate by an ant, *Acanthomyops claviger*, have been reported.^{192a} These results showed that ants can synthesize terpenoid compounds which are important in chemical communication and that they do not have to rely on preformed terpenes in their food.

In studies on the biosynthesis of artemisia ketone, it was found that MVA-2-¹⁴C was incorporated into myrcene (XXVIII) produced by *S. chaemocypris*.⁴⁰⁸

In addition to mycelianamide (XXXIII), the occurrence of several naturally occurring compounds containing an isopentenyl sidechain are known (Fig. 8). Mycophenolic acid, which is another mold metabolite (*P. griseofulvum*), has a C₇ sidechain which is regarded as a remnant of an oxidized C₁₀ chain. Birch *et al.*⁶³ have also studied the biosynthesis of mycophenolic acid from acetate-1-¹⁴C. The ergot alkaloids, which are of considerable pharmacological and chemical interest, are known to be biosynthesized from tryptophan(XXXVII) and

† It was assumed that no geometric isomerization of the double bonds within the rabbit occurred; consequently, the carboxyl carbon would be derived from the methyl group, which was originally *trans*.

MVA (XI),^{5, 417} of which the alkaloid chanoclavin-I (XXXVIII) will serve as an example. Another related fungal metabolite of isoprenoid origin (and also of tryptophan) is echinulin (XXXIX),³²³ in which mevalonate-derived side-chains are attached to the indole nucleus at carbons 5, 7, and 3.

Several terpenoid guanidines are known; sphaerophysin (XL) from *Sphaerophysa salsula* can be formed from mevalonate.^{322, 374} The isoprenylated phloro-

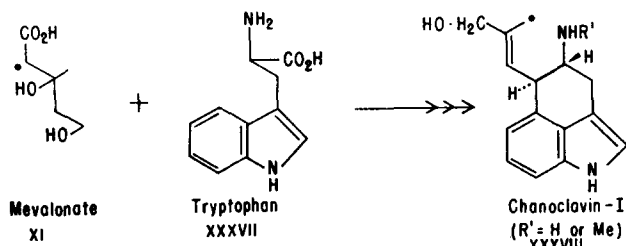

glucinol, humulone (XLI), can be formed from MVA-2-¹⁴C and leucine-2-¹⁴C in the branches bearing developing cones of *Humulus lupulus* (hop plant).²⁵⁰ A preliminary degradation of the carbon-14 labeled product showed label from leucine in the isovaleryl group of humulone.

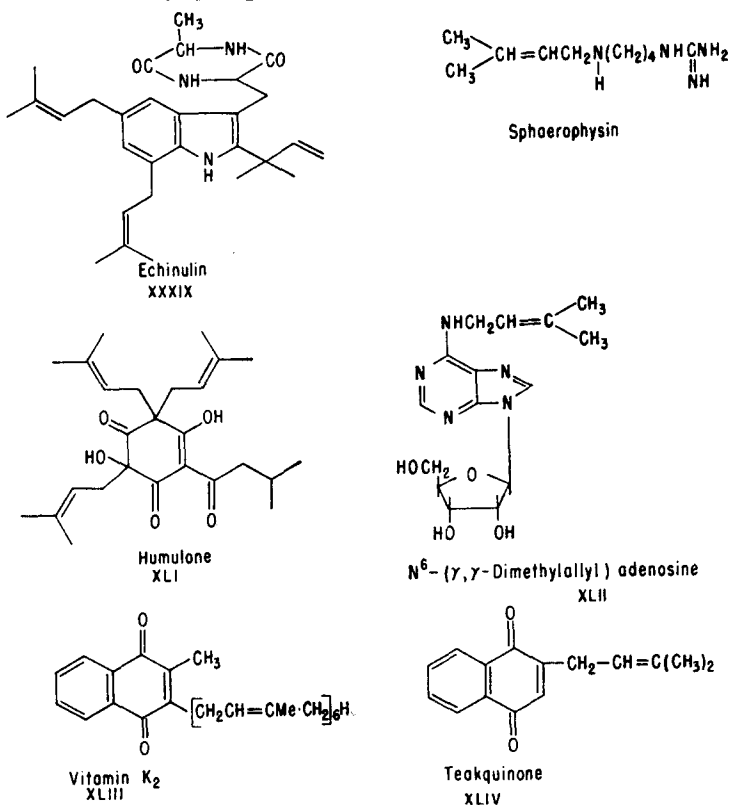
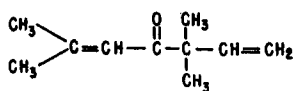

FIG. 8. Non-isoprenoid nuclei alkylated by isoprenoid or polyisoprenoid groups.

The occurrence of several naturally occurring compounds containing an isoprenoid sidechain attached to adenine has been reported. The adenine-isoprenoid compound (XLII) isolated from yeast s-RNA¹⁸⁵ can promote cell division and differentiation (a cytokinin), which makes it of special interest for future studies.

Finally, the vitamins (E and K) and related compounds, such as coenzyme Q, which represents an alkylation by isoprenoid or polyisoprenoid groups, should be pointed out (the structure of Vitamin K₂ serves as an example) (XLIII). More information on this group of compounds possessing an isoprenoid sidechain will be discussed in a later section. Of interest is a related toxic isoprenoid, naphthoquinone (XLIV), isolated from *Tectona grandis* (teak).³⁵¹

ii. *Non-head-to-tail monoterpenoids*. Artemisia ketone (XLV) is regarded as an atypical monoterpene in which the tail of one isoprene unit is linked to one of the central carbon atoms of the other, in contrast with the usual head-to-tail arrangement. In biosynthesis studies in *Santolina chaemycparissus* L. plants employing MVA-2-¹⁴C as a precursor, it was found that five monoterpene hydrocarbons (including the open-chain compound myrcene (XXVIII) and the bicyclic monoterpene, β -pinene (LXII)), were labeled (300 to 1500 times the artemisia ketone), but no significant amount of label was found in the artemisia



XLV Artemisia Ketone

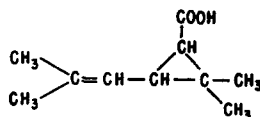

XLVI Chrysanthemic Acid

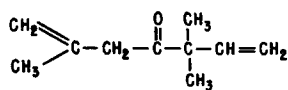
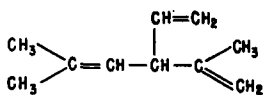
Iso-Artemisia Ketone
XLVII2,5-dimethyl-3-vinylhexa-1,4-diene
LXVIII

ketone.⁴⁰⁸ This finding is in contrast with an earlier study performed on the biosynthesis of chrysanthemic acid (XLVI), another atypical monoterpene,^{126, 164} where it was shown that mevalonate-2-¹⁴C was the precursor and that the carbon-14 label was found in the terminal methyl carbon atoms in agreement with a non-head-to-tail mevalonate precursor hypothesis.

Chrysanthemic acid (XLVI) has a structure similar to that of artemisia ketone, but in addition has a cyclopropane ring. It is logical to assume that the biogeneses of these two compounds are related and several biogenetic schemes involving isoprene units²⁸⁵ have been proposed, the most recent being that of Bates and Paknikar.³⁴

Related non-head-to-tail isoprenoid compounds are iso-artemisia ketone

(XLVII) and 2,5-dimethyl-3-vinylhexa-1,4-diene (XLVIII), which are probably involved in the biosynthesis of the above compounds.³⁸⁵

Of interest is the finding that the long-chain linear paraffin heptacosane, produced by *Wistaria sinensis* (wisteria) flowers, is labeled from MVA-2-¹⁴C on the same order of magnitude as from succinate-2,3-¹⁴C and pyruvate-2-¹⁴C.⁷⁷ The authors concluded that MVA was probably broken down to smaller molecules before being utilized in heptacosane biosynthesis.

2. Monocyclic monoterpenes

In developing the biogenetic isoprene rule, Ruzicka³⁸⁵ suggested a series of ionic mechanisms (Fig. 9) for the formation of cyclic monoterpenes from a C₁₀ alcohol (i.e., geraniol, XXII) or radical mechanisms (Fig. 10) for similar cyclization of a C₁₀ hydrocarbon (myrcene, XXVIII; or ocimene, XXIX). Since no experimental evidence has as yet appeared to either support or negate this theory,

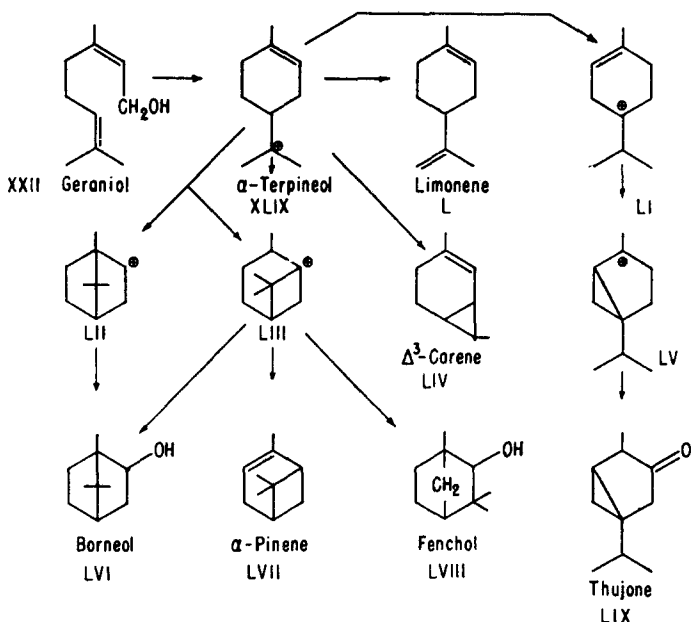

FIG. 9. Ionic mechanisms in the biogenesis of monoterpenes.³⁸⁵

it still remains a working hypothesis. It seems more logical to this author that enzymically catalyzed ring closure would employ the biologically active form of geraniol, i.e., geranylpyrophosphate (XIX). It should be pointed out that nerylpyrophosphate may be a more direct precursor than GPP (XIX) since it has a configuration more compatible with direct cyclization. In an interesting non-enzyme analogy, it was found²⁷⁰ that in an ether solution at room temperature neryldiphenylphosphate (LXIV) with a *cis*-allylic double bond gave a 45 per cent yield of limonene (L), whereas geranyldiphenylphosphate was transformed very slowly to a small amount of myrcene (XXVIII) and ocimene (XXIX) (Fig. 11).

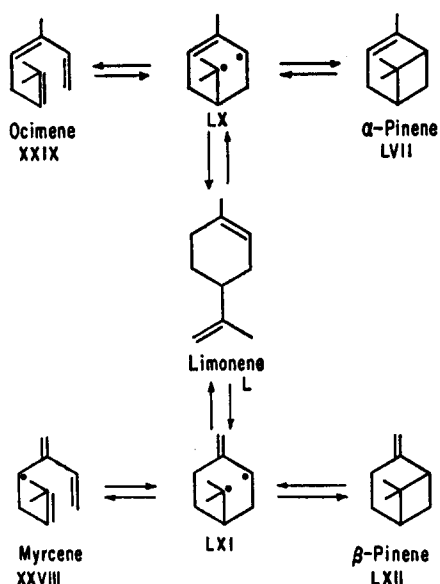

FIG. 10. Radical mechanisms in the biogenesis of monoterpenes.³³⁵

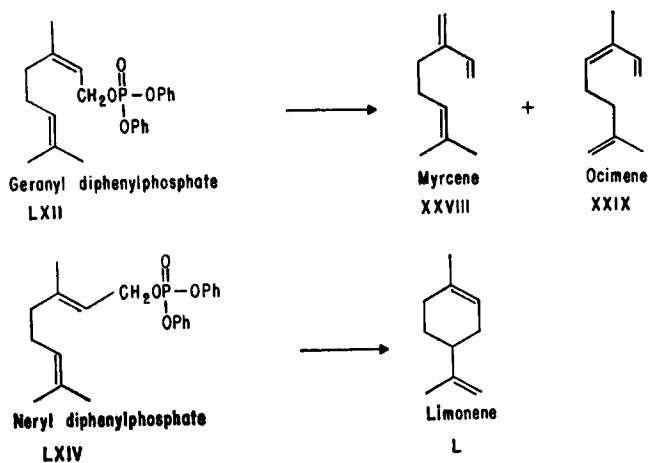
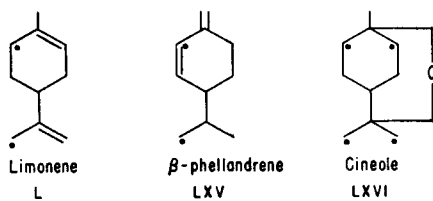

FIG. 11. Non-enzymatic cyclization of geranyl- and neryldiphenylphosphate.²⁷⁰

The biosynthesis of limonene (L) from MVA-2-¹⁴C in *Pinus pinea* L.^{346, 348} resulted in the distribution of label shown. Likewise, it was established that



β -phellandrene (LXV) formed from MVA-2- ^{14}C by *Pinus contorta*⁸⁵ had a similar labeling pattern. These results show that the terminal methyl groups are not equivalent and offer additional evidence to support the stereochemical dimerization of the biologically active isoprene unit.

Birch *et al.*⁶¹ showed that mevalonic lactone-2- ^{14}C is incorporated as indicated into cineole (LXVI) produced by *Eucalyptus globulus*; however, Arigoni¹⁹ reports that label from MVA-2- ^{14}C is completely randomized before incorporation into this monoterpeneoid.

It was found by Battaile and Loomis⁸⁵ that labeled terpenes are formed in young peppermint leaves in less than an hour after $^{14}\text{CO}_2$ administration, whereas mevalonate was not incorporated into monoterpenes in detectable amounts (cut leaves of the peppermint plant). In contrast, Hefendehl *et al.*^{195, 196} reported the incorporation of MVA-2- ^{14}C into the monoterpenes of several varieties of peppermint oil, and their evidence suggested that piperitenone¹⁹⁶ was not the first precursor in the biosynthesis of the oxygenated monoterpenes. The Loomis group, using labeled terpenes as substrates for leaf slices, demonstrated the conversion of piperitenone (LXVII) to piperitone (LXVIII), of pulegone (LXIX) to menthone (LXX) and of pulegone (LXIX) to menthofuran (LXXI). Menthol (LXXIII)²⁷¹ can be formed from acetate-1- ^{14}C and the label is in carbons 1, 3, and 8. Reitsema in 1958⁸¹⁹ proposed a scheme of terpene interconversion, mostly reductive, to account for the formation of the principal monoterpenes in peppermint oil. The scheme has been revised to agree with the recent findings by Loomis⁸⁸ and is shown in Fig. 12. The revised scheme accounts for the formation of isomenthone and of the several isomers of menthol which are found as minor components of peppermint oil.

The biosynthesis of limonene (L) and carvone (LXXIX) produced by *Anethum graveolens* was studied using MVA-2- ^{14}C , and the label was distributed as shown. The specific activity of limonene (L) was about three times that of

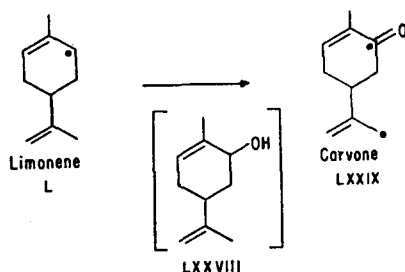

carvone (LXXIX), indicating that it is probably the precursor. A similar study³⁶⁵ was conducted using *Carum carvi* (caraway) and the results obtained indicated that no migration of the double bond occurred in the conversion of limonene (L) to carvone (LXXIX). This conclusion was based on retention of the same distribution of label of the terminal methyl carbons (4:1) in limonene and carvone. Supporting evidence from the incorporation of $^{14}\text{CO}_2$ into the monoterpene hydrocarbon of *Mentha piperita* has recently been provided.^{196a}

It is important to recognize that incorporation of carbon-14 into mono-

terpenes has been consistently low [approximately 0.1 per cent, except for certain of the methylcyclopentane monoterpenoids such as skyanthine (LXXX) and verbenalin (LXXXIII)] in the monoterpenes studied to date. The recent report⁴² that MVA-2-¹⁴C is not directly incorporated into peppermint monoterpenes, but is first degraded to ¹⁴CO₂ and subsequently labeled monoterpenes appear via carbon dioxide fixation, indicates once again that it is necessary to be cautious

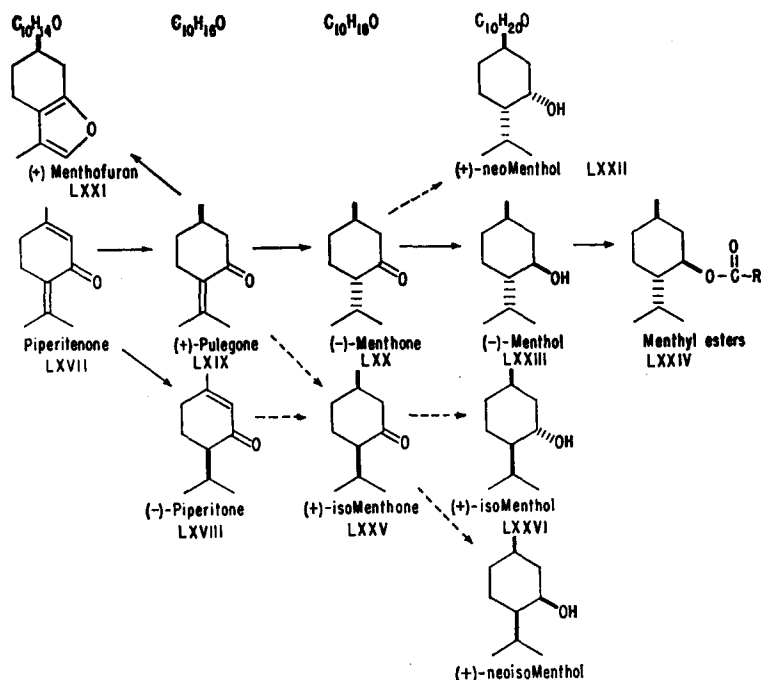

FIG. 12. Biochemical relationships of monoterpenes in peppermint. Dotted arrows indicate postulated reactions.^{88, 319}

about making the definite conclusions that have appeared in the literature. Loomis and Burbott²⁴⁹ have compared the efficiency of incorporation into peppermint monoterpenes of acetate-2-¹⁴C, MVA-2-¹⁴C, glycolate-2-¹⁴C, glyoxylate-2-¹⁴C, pyruvate-2-¹⁴C, serine-2-¹⁴C, alanine-2-¹⁴C, ribose-1-¹⁴C, glucose-1-¹⁴C, -2-¹⁴C, -3,4-¹⁴C, and -6-¹⁴C, and ¹⁴CO₂, and concluded that glucose and CO₂ are the best precursors. More will be said about the difficulties encountered in monoterpene biosynthesis in the section on regulation of terpenoid metabolism.

3. Bicyclic monoterpenes

It has already been mentioned that Ruzicka³³⁵ has postulated ionic (Fig. 9) and radical (Fig. 10) mechanisms for the biogenesis of some of the bicyclic monoterpenes. As mentioned for the monocyclic monoterpenes, these schemes still represent good working hypotheses. The proposed schemes do not cover

methylcyclopentane monoterpeneoids, which represent a special class, for the most part, of bicyclic monoterpeneoids.

i. *Methylcyclopentane monoterpeneoids*. The class of naturally occurring compounds known as the methylcyclopentane monoterpeneoids are gaining increased recognition because of their varied and somewhat exotic types of biological activity and because they provide a structural link between terpenes and alkaloids, two previously divergent classes of natural products that have interested scientists for many years. The methylcyclopentane compounds have powerful biological activity including antibiotic,¹⁵⁷ insecticide,¹⁵⁷ insect repellent and attractant,^{106, 146, 328, 342} feline attractant,^{13, 154, 263, 264, 339, 389} canine attractant,³⁸⁸ arthropod defense,^{105, 147, 262, 267, 326} antidiabetic^{13, 187} and the ability to stimulate the learning capacity of rats.^{13, 158} This is in contrast to the usual physiological inertness of the classical monoterpeneoids.

The occurrence of compounds which possess a methylcyclopentane monoterpeneoid ring system is widespread in nature. They are composed of three groups: oxygenated monoterpeneoids, alkaloids, and glucosides (the sugar moiety is β -D-glucose). Several laboratories have studied the biosynthesis of these compounds and the evidence for their isoprenoid origin is now well established.

The first report on the biosynthesis of a methylcyclopentane monoterpeneoid was on skytanthine (LXXX) (Fig. 13) by Marini-Bettolo's group.^{99, 100} A more detailed investigation on this alkaloid, which is also the most detailed study to appear on a methylcyclopentane monoterpeneoid, recently appeared.²² A mixture of alkaloids is obtained from *Skytanthus acutus* M., a plant native to

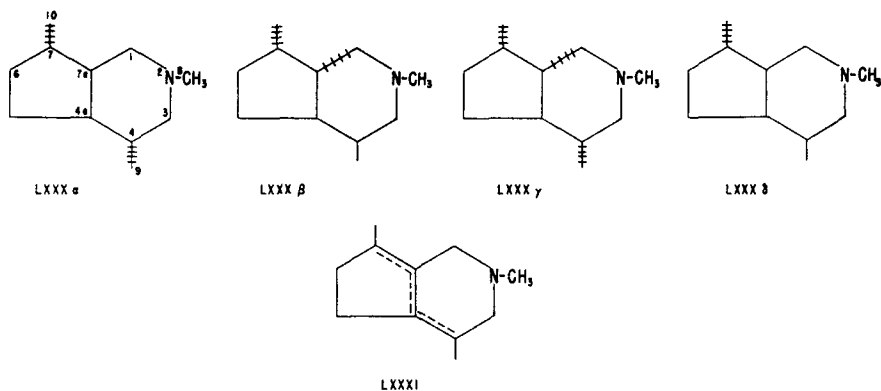

FIG. 13. Structures of *Skytanthus* alkaloids.^{22, 143} The Greek letters refer to isomers of skytanthine (LXXX). LXXXI is dehydroskytanthine.

the Atacama desert of Chile (Fig. 13). At least three skytanthine isomers (LXXX, α , β , and δ) and a dehydroskytanthine (LXXXI) are known.^{22, 143} The amounts of these alkaloids vary with the parts of the plant with the roots containing the most. Biosynthesis experiments (96 hours)²² were conducted using methionine-methyl-¹⁴C and MVA-2-¹⁴C as precursors. Specific activities of the skytanthine alkaloids were found to vary in different parts of the plant.

Chemical degradations on micro quantities of alkaloid, to eliminate nitrogen and to determine the amount of radioactivity located in carbons 3, 4, 7, 9, and 10, were devised.²² It was found that L-methionine-methyl-¹⁴C was the precursor of the N-methyl group of β -skytanthine. The results of biosynthesis experiments using MVA-2-¹⁴C as a precursor provided evidence for the formation of skytanthine isomers via: (a) an isoprenoid pathway which involved randomization of the label between the terminal methyl carbon atoms of the monoterpene or monoterpene (i.e., geranylpyrophosphate, XIX) intermediate in 1.3-year-old plants; and (b) an isoprenoid pathway which did not involve randomization of the label between the monoterpene terminal methyl carbon atoms in 3-year-old plants (Fig. 14). To explain these findings, Auda *et al.*²² proposed several

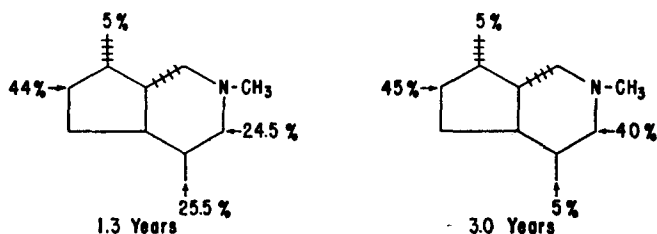
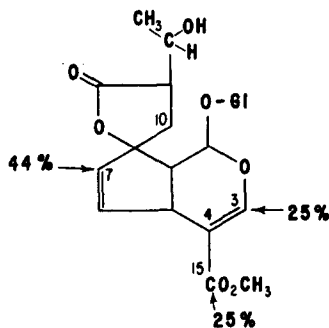

FIG. 14. Labeling patterns in β -skytanthine formed from mevalonate-2-¹⁴C by *Skytanthus acutus* M.²²

types of enzyme control systems. They postulated that different enzymes inhibitors or different levels of enzyme might be present in the young and old plants. It may even be possible that the enzyme responsible for randomization of the monoterpene intermediate does not exist in the old plant. Control by the substrate pool size was also postulated. Perhaps this can be best visualized by considering that the young plant has a rather large pool of monoterpene intermediate and that the two terminal methyls become equivalent; whereas, in the old plant, only a small pool of monoterpene intermediate exists and the substrate is immediately utilized in the biosynthesis and does not remain in the pool long enough for randomization of the methyl carbons to occur. The possibility that randomization of the label in the 1.3-year-old plants was due to degradation of MVA to carbon dioxide and reincorporation of the latter into MVA (to provide MVA-U-¹⁴C) was not investigated due to the shortage of labeled alkaloid. Battu and Youngken⁴² recently reported on the degradation of MVA to carbon dioxide and reincorporation of the latter into monoterpenes of *Mentha piperita* by CO₂ fixation. Other evidence by Regnier *et al.*³¹⁶ has shown that MVA-2-¹⁴C is degraded to ¹⁴CO₂, but the maximum amount produced by *Nepeta cataria* after 48 hours was 0.2 per cent. Variation in an enzymatic reaction mechanism due to age is a new phenomenon and it remains to be studied more thoroughly before an acceptable explanation is forthcoming.

Yeowell and Schmid⁴²⁹ have studied the biosynthesis of plumieride (LXXXII) produced by *Plumiera acutifolia* using acetate-1-¹⁴C and MVA-2-¹⁴C and found radioactivity in only the aglucone moiety. Results from chemical degradation of plumieride formed biosynthetically from MVA-2-¹⁴C showed that random-

ization occurred between carbon atoms 3 and 15 (about 25 per cent of the radioactivity residing in each), and that carbon 7 contained 44 per cent. It can be assumed that carbon atom 10 would contain about 6 per cent of the radioactivity, which is in agreement with our finding on β -skytanthine. Yeowell and



PLUMIERIDE
LXXXII

Schmid⁴²⁹ suggested that randomization might occur after ring closure of the cyclopentanoid ring and that carbon atoms 3 and 15 might be equivalent aldehyde groups. Randomization of the terminal methyl label in the isoprenoid portion of certain indole alkaloids has also been reported^{39, 165, 261} and the proposed mechanisms are similar to that suggested for plumieride. These data are also supported by labeling experiments using geranylpyrophosphate-2-¹⁴C (XIX)^{36, 39, 40, 165, 245} and geraniol-2-¹⁴C (XXII).^{40, 184, 245} It seems logical that randomization might occur at the monoterpenoid level in these compounds since carbon 15 of plumieride is further oxidized to a carboxylic acid group and this biological oxidation might be expected to proceed in a stepwise direction involving alcohol, aldehyde, and finally acid.

Schmid's group²¹¹ studied the biosynthesis of verbenalin (LXXXIII), another methylcyclopentane monoterpenoid glucoside. The results they obtained using

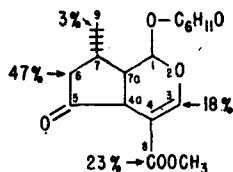

Verbenalin
LXXXIII

MVA-2-¹⁴C as a precursor of verbenalin (LXXXIII) produced by young plants of *Verbena officinalis* show that randomization of the label occurred between carbon atoms 3 and 8 (18 per cent and 23 per cent of the radioactivity residing in each, respectively) and that carbon atoms 7 and 9 contained 3 per cent of the radioactivity as illustrated above. Concurrent with the investigation of the Swiss group,²¹¹ studies in our laboratory by Horodysky *et al.*^{144, 209} showed that

little randomization of the label occurred in verbenalin (LXXXIII) produced by mature, flowering *V. officinalis* plants (see structure above). In order to resolve this apparent disparity in labeling patterns using MVA-2-¹⁴C as a precursor, the effect of age of *V. officinalis* plants upon the degree of randomization was studied.^{144, 209} Plants of one, two, three, and four months of age were fed MVA-2-¹⁴C and the verbenalin-¹⁴C was isolated and partially degraded. The results are illustrated in Fig. 15. The radioactivity which appeared in carbon

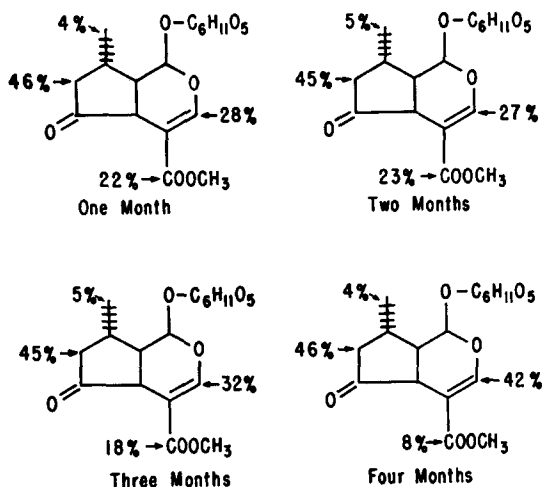
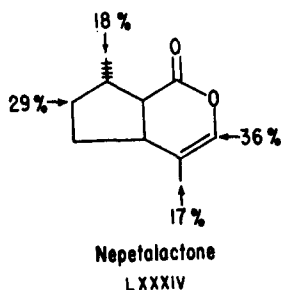

FIG. 15. Labeling patterns in verbenalin (LXXXIII) with respect to plant age, using mevalonate-2-¹⁴C as a precursor.²⁰⁹

atoms 7 and 9 of verbenalin (LXXXIII) contained 4.1 ± 0.4 per cent of the aglucone portion of the molecule for plants aged one, two, three, and four months. Thus, carbon atom 9 had approximately 4 per cent of the radioactivity, and by difference, carbon atom 6 would have approximately 46 per cent of the radioactivity in each of the four sets of plants. Randomization between carbon atoms 6 and 9 does not occur in young, mature, or senile *V. officinalis* plants. In contrast to these results, it was found that the radioactivity appearing in carbon atoms 4 and 8 contained 22, 23, 18, and 8 per cent of the activity of the aglucone portion of verbenalin (LXXXIII). By difference, carbon atom 3 would be expected to have 28, 27, 32 and 42 per cent of the radioactivity of the aglucone portion of verbenalin (LXXXIII) for plants aged one, two, three, and four months. The evidence points towards a randomization of the label between carbon atoms 3 and 8 for young *V. officinalis* plants, an intermediate stage at which limited randomization occurs, and finally the stage at which non-randomization occurs (the mature plant). These results parallel the findings on the biosynthesis of β -skytanthine (LXXX) discussed earlier.²²

The metabolic relationship between MVA-2-¹⁴C and nepetalactone (LXXXIV) in flowering *Nepeta cataria* L. plants has been examined.³¹⁶ A limited randomization of the carbon-14 was found in carbon atoms 3 and 8 and also carbon

atoms 6 and 9. With respect to the limited randomization between carbon atoms 3 and 8, the biosynthesis of nepetalactone is similar to that found for the biosynthesis of verbenalin (LXXXIII) by intermediately mature, non-flowering *V. officinalis* plants. However, a major difference between the biosynthesis of nepetalactone (LXXXIV) and β -skytanthine (LXXX- β), plumieride (LXXXII),



or verbenalin (LXXXIII) is the evidence for the high amount of carbon-14 located in carbon 9. The fact that the per cent carbon-14 located in carbon 9 is about equal to that found in carbon 8 suggests that some randomization can occur at the IpPP (XVI) level. This finding needs further study before it is completely understood since the evidence to date tends to support the mechanism of isomerization of isopentenylpyrophosphate proposed first by Agranoff *et al.*⁴ and later established by Shah *et al.*³⁵⁸

It has now been established that actinidine (LXXXV)³⁴⁰ from *Actinidia polygama* can be formed via an isoprenoid route.²³ This finding is also of interest in the field of alkaloid chemistry, since it represents the third pathway for the

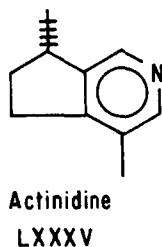

biosynthesis of the pyridine alkaloids in plants. No studies were conducted to determine the location of the label in actinidine formed from MVA-2-¹⁴C due to the small amounts of the alkaloid produced in the biosynthesis experiments.

Of a number of biogenic schemes that have been proposed for the non-rearranged methylcyclopentane monoterpenoids, only the most recent one of these which incorporates the information available on their biosynthesis will be presented¹⁴⁵ (Fig. 16). For earlier proposals and for background information on the chemistry of these compounds, the reader is referred to refs. 32, 104, 111, 145, and 323. More explanation is necessary for this biogenetic pathway than others previously discussed because of its newness and uniqueness. Because of the widespread occurrence of geranylpyrophosphate (XIX) and its known

biological reactivity, it may be considered a very likely intermediate for ring closure to yield the methylcyclopentene aldehydropyrophosphate (LXXXVIII) by utilizing the hydroxy- and aldehydo-pyrophosphates (LXXXVI, LXXXVII). Structure LXXXIX may be considered the key biological intermediate, and branches leading from it to the formation of the methylcyclopentane mono-terpenoid alkaloids and the highly oxygenated methylcyclopentane mono-terpenoids are shown.

Since the two asymmetric centers (4a and 7) of the methylcyclopentane mono-terpenoids are identical throughout this series, it is likely that the methylcyclopentane ring must cyclize at an early stage of structure formation to fix the stereochemistry of the ring junction at 4a and the methyl group at 7 for the entire series. The stereochemistry of the asymmetric centers other than 4a and 7 is varied at times in the series. This is especially apparent in products from *Skytanthus acutus*, which produces three diastereoisomeric skytanthines (LXXX- α , β , γ) differing at carbons 4 and 7a. The multiplicity of skytanthine isomers would suggest that the nitrogen-containing ring cyclized at a later stage than the methylcyclopentane ring. Thus, the skytanthine isomers may arise from a common precursor which permits a multiplicity of isomers to be formed during ring closure.

The formation of XC (alkaloid route) may be rationalized as taking place through biological transamination of LXXIX. The intermediate XC is structurally attractive because the most receptive carbonyl of LXXXIX would be utilized during amination and the presence of the allylic double bond would greatly facilitate intramolecular nucleophilic displacement of pyrophosphate by the amino group. This process would yield XCI, and the succeeding dehydration step leading to the dienamine mixture XCII-a, b, and c would be expected to take place readily. It seems likely that an equilibrium could exist between XCII-a, b, and c, which would permit stereoselective enzymatic partial reduction to the nor- α , β , and γ skytanthines (XCIII) with the expected fixed stereochemistry resulting at positions 4a and 7, as well as enzymatic dehydrogenation to actinidine (LXXXV). While the mode of formation of XCII-a, b, and c is obscure, the existence of nor-skytanthine[†] is compelling evidence of at least fleeting presence of such intermediates. It is possible that XCII-a, b, and c are enzyme-bound intermediates which are not released and, therefore, not observed. The addition of water across a nor-dehydroskytanthine (XCIV) with the double bond between carbons 4 and 4a gives rise to hydroxyskytanthine (XCV).³³ Tecomanine (XCVI)²¹⁹ could be formed by methylation and oxidation of a nor-dehydroskytanthine (XCIV) (double bond between carbons 4a and 5) at carbon 6. Hydroxyactinidine or tecostidine (XCVII)^{188, 189} can be formed by terminal methyl oxidation of carbon 9 of actinidine (LXXXV)³⁴⁰ or by oxidation of XCII-c, a route going through the partially unsaturated compound (XCVIII). Actinidine (LXXXV) may be formed by the aromatization of XCII-b or by dehydration of XCVIII.

† Unpublished mass and nuclear magnetic resonance spectral data from our laboratories.

The formation of XCIX (oxygenated monoterpene route) would be expected to occur by hydrogenation and would be followed by removal of pyrophosphate to give C. C would be in equilibrium with iridodial (CI)¹⁰⁴ and CIII. Iridodial (CI) is in equilibrium with its bicyclic form (CII), which can be readily oxidized to nepetalactone (LXXXIV) by alcohol dehydrogenase. Dihydronepetalactone (CVI)³⁴¹ and iridomyrmecin (CVII)¹⁰⁴ can be formed in an analogous fashion from C and CIV, respectively. By a slight modification of the reaction sequence initiating with the key intermediate LXXXIX, most of the other oxygenated methylcyclopentane monoterpenoids can be formed.¹⁴⁵ A careful study indicates that a pattern of increasing unsaturation and oxygen content (also true for the nitrogenous series) is evident. This gradation is probably due to biosynthetic processes that appeared later in the evolutionary development of the plants. There also exists a series of compounds^{32, 104, 323}—namely, aucubin, genipinic acid, and catalposide—that have a methyl group missing at carbon 4 (see Fig. 13, LXXX for numbering); these compounds are probably formed initially as regular oxygenated methylcyclopentane monoterpenoids, but later lose a methyl group by selective degradation. This hypothesis¹⁴⁵ has the advantage of a unified biogenesis route which provides for the possible formation of all methylcyclopentane monoterpene isomers with variation at carbons 4 and 7a.

ii. *Six-membered ring monoterpenoids.* These bicyclic terpenes and terpenoids were shown to arise via an isoprenoid pathway by Stanley,³⁶⁷ who administered labeled MVA to *Pinus attenuata* stems. Turpentine was isolated from the plant; and the α -pinene (LVII), which is the major constituent of the turpentine of this species, was shown to be labeled with carbon-14.

Sandermann and Schweers reported that MVA-2-¹⁴C can serve as a precursor of α -pinene (LVII)³⁴⁹ produced by *Pinus nigro* A. and thujone (LIX)³⁵⁰ by *Thuja occidentalis*. The position of labeling in these molecules was determined and found to be consistent with the proposed isoprenoid biosynthetic route already



discussed. β -Pinene (LXII) can be formed from MVA-2-¹⁴C by *Santolina chamaecyparissus* L.; however, the distribution of label was not determined.⁴⁰⁸ MVA-2-¹⁴C and ¹⁴CO₂ were found to label β -pinene (LXII), α -pinene (LVII) and limonene (L) by young *Pinus radiata* seedlings.³⁹⁸ More ¹⁴CO₂ was incorporated into β -pinene than into α -pinene in one-year-old trees; however, in isolated needles, the α -isomer attained a higher specific activity than the β -isomer. In a cell-free extract, 0.05 per cent of label from MVA-2-¹⁴C was incorporated into limonene, but synthesis of the pinenes was not observed.³⁹⁸

Sandermann and Schweers^{349, 350} have suggested a biogenetic route which

could explain the formation of the bicyclic monoterpene hydrocarbons (Fig. 17).

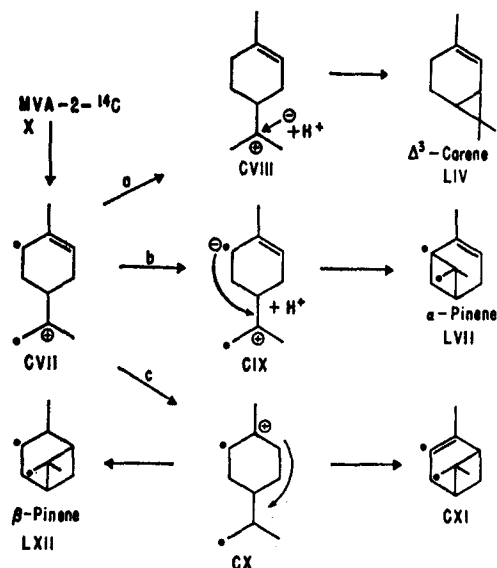

FIG. 17. Biogenesis of bicyclic monoterpene hydrocarbons.^{349, 350}

4. Tricyclic monoterpenes

No work on the biosynthesis of these compounds has appeared. Tricyclene (CXIII)³⁰⁶ has been isolated from oil of the Siberian pine-needle. The oils have a relatively high amount of camphene (CXVII) and bornyl acetate (derived from LVI). A biogenetic relationship (Fig. 18) has been suggested by Weissman⁴¹¹ that also includes the formation of bornylene (CXVI).

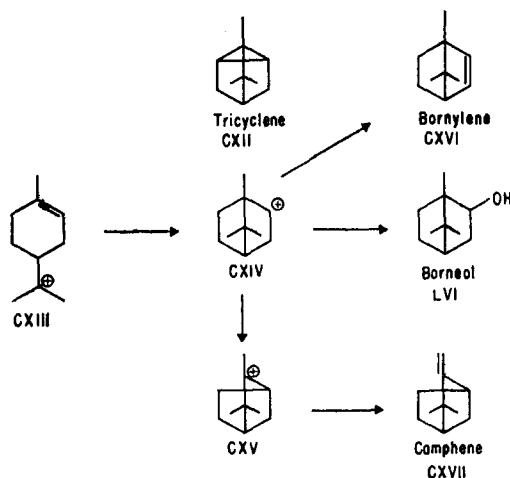
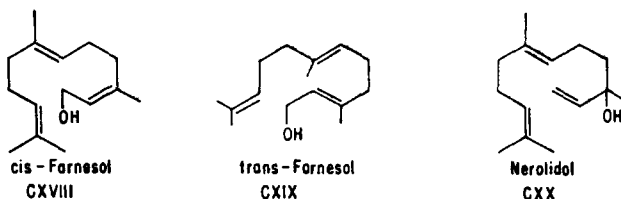

FIG. 18. Biogenesis of bi- and tricyclic monoterpenes.⁴¹¹

D. Sesquiterpenoids

The biosyntheses of the complex series of natural sesquiterpenes (C_{15}) have not been studied as extensively as has the monoterpene family, although biogenetic proposals are numerous.^{323, 335, 336, 411} They are believed to be derived from farnesylpyrophosphate (XX) by a series of appropriate cyclization with the additional assumption that the central double bond is *trans* (by analogy to squalene) and that the terminal double bond may be either *cis* or *trans*. The *cis-trans* isomerization [CXVIII and CXIX] could arise from an allylic rearrangement to give the nerolidol (CXX) type skeleton. *Cis*-farnesol (CXVIII) bears the same relation to nerolidol (CXX) as geraniol (XXII) does to linalool (XXV).



Only a single report on the biosynthesis of monocyclic sesquiterpenes has appeared, and that was on humulene³¹⁶ (Fig. 19, structure CXXXII) produced by *Nepeta cataria* (catnip) from MVA-2-¹⁴C. The bicyclic sesquiterpene, carophyllene,³¹⁶ was also labeled. It was of interest that incorporation of radioactivity from MVA-2-¹⁴C into the terpene hydrocarbon fraction of *N. cataria* reached a maximum 50 hours following administration of the precursor and remained constant for a ten-day period whereas radioactivity incorporated into the monoterpene, nepetalactone, leveled off at 12 hours, remained constant for 125 hours, and then began to increase again.

The biosynthesis of four other bicyclic sesquiterpenes, carotol (CXXI), ipomeamarone (CXXII), helminthosporal (CXXVII), and xanthinin (CXXIII), have been studied. Carotol (CXXI) from carrot seed can be formed from acetate-1-¹⁴C and the labeling pattern obtained suggested a preferred mode of cyclization of FPP (XX).³⁶⁴ The distribution of label in ipomeamarone (CXXII)

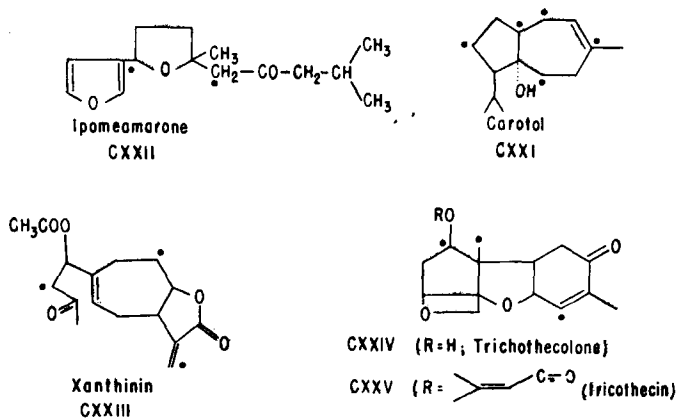

synthesized by black rot sweet potato root tissues from acetate-2-¹⁴C and MVA-2-¹⁴C verifies the isoprenoid origin of this interesting sesquiterpene.^{6, 294a} Extensive enzymatic oxidation of FPP (XX) probably occurs, since no cyclization to carbocyclic rings occurs in this compound. Helminthosporal (Fig. 19, CXXVII), the fungal toxin produced by *Helminthosporium sativum*, incorporates radioactivity from MVA-2-¹⁴C³¹ and it was shown that 38 per cent of the label was in the unsaturated aldehyde carbon atom, which is in good agreement with the expected value if this carbon were one of three derived from carbon-2 of MVA (XI).

Xanthinin (CXXIII), a lactone of the guaione type, can be formed from MVA-2-¹⁴C by *Xanthium strumarium* with the pattern of label consistent with FPP (XX) as a precursor.⁴⁰⁴

Longifolene (CXXVI), a tricyclic sesquiterpene, is formed from acetate-1-¹⁴C³⁴⁵ in *Pinus longifolia*. Chemical degradation showed that the exocyclic methylene group was essentially devoid of activity (the activity found was 1.6 per cent of that anticipated). The authors stated that biosynthesis of longifolene occurs via rearrangements of a normal sesquiterpene (Fig. 19).

The antibacterial sesquiterpenoid, marasmic acid (CXXVI-a), isolated from *Marasmius conigenus* cultures, is labeled from MVA-2-¹⁴C. Chemical degradation of the marasmic acid-¹⁴C showed that about 33 per cent of the label was located in the geminal dimethyl group, about 26 per cent in the cyclopropane methylene carbon (or in the adjacent carbon atom), and these results led the authors¹³⁸ to suggest the labeling pattern shown. A humulene-type (CXXXII) precursor (see Fig. 19) was suggested as an intermediate.

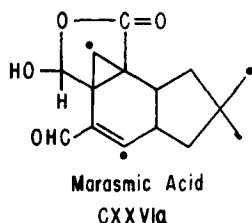

The pathogenic fungus *Trichothecium roseum* produces trichothecin [(CXXV) see also trichothecolone (CXXIV)], a tetracyclic sesquiterpenoid. This compound is formed from MVA-2-¹⁴C, and from the labeling pattern obtained²¹⁸ an explanation of its formation from FPP was proposed. The stereochemical aspects of this transformation and its importance in the formation of bisabolene (CXXIX) have been discussed by Ruzicka.³³⁷

Bu'Lock⁸⁷ has summarized the biogenetic sequences beginning with farnesene† (CXXVIII), used to explain the labeling patterns obtained from longifolene (CXXVI), helminthosporal (CXXVII), and trichothecolone (CXXIV) biosynthesis experiments. It is of interest to note that in a non-enzymatic study of the hydrolysis of *trans*-nerolidyl phosphate both isomers of bisabolol (see

† Although it would seem more likely to use FPP as the initial precursor of the sesquiterpenoids.

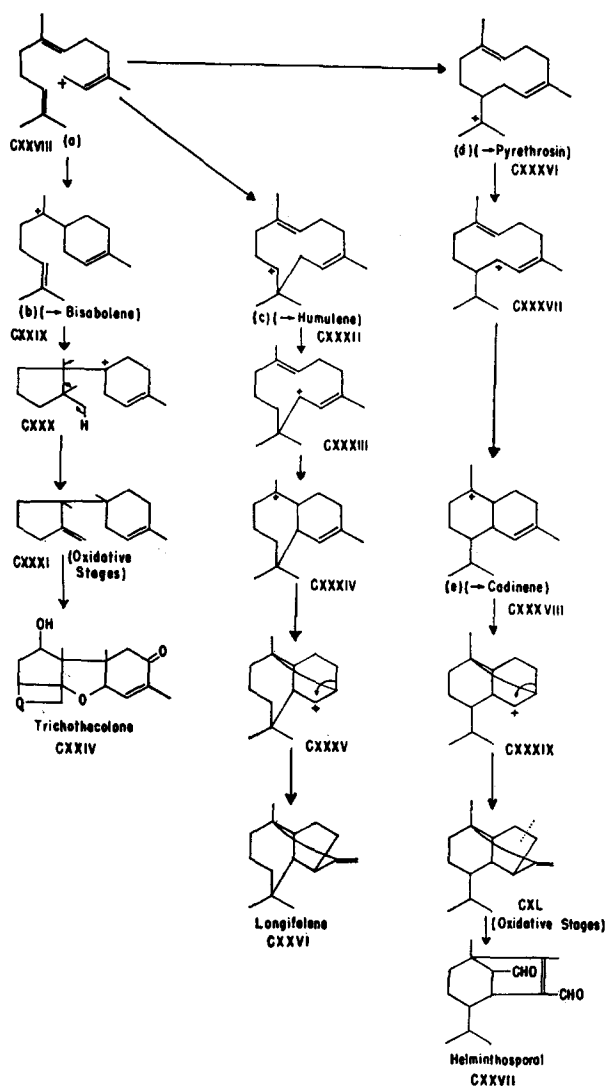

FIG. 19. Biogenetic sequences in the formation of selected sesquiterpenoids.⁸⁷ Arrows denote formation of terpene hydrocarbon from the carbonium ion.

structure CXXIX for the hydrocarbon structure) are formed.³²⁴ These results are somewhat analogous to those cited earlier regarding the non-enzymatic preferred ring closure of nerylpyrophosphate²⁷⁰ as compared with GPP (XIX).

E. Diterpenoids

Considerably more interest has been shown in the biosynthesis of diterpenoid compounds than the sesquiterpenoids. Presumably this is because of their biological activity (i.e., regulation of plant growth and development as shown

by the gibberellins), but it is due partly to their more complicated structures,† which present a challenge to the natural product chemist or biochemist who endeavors to determine their labeling pattern through chemical degradation methods. In general, the basic structural unit of the diterpenes and their derivatives is geranylgeranylpyrophosphate (XXI) (C_{20} -terpenol pyrophosphate), which can be formed as described earlier (Fig. 6).^{175, 181, 221, 276, 298}

Geranylgeraniol (CXL) and its dehydration product, farnesene, have been reported to occur in tomato fruits.³⁸⁷ The allylic isomer, geranyl-linalool (CXLI), has been isolated from jasmine oil.²⁹⁶ Geranyl-linalool (CXLI) was considered by Ruzicka^{385, 386} to be the most logical precursor of the diterpenes.

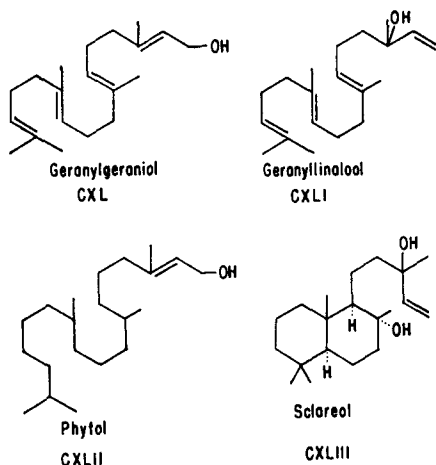

The terpenoid moiety of chlorophyll, phytol (CXLII), is presumably formed from geranylgeraniol (CXL) since the latter diluted the incorporation of acetate- ^{14}C and MVA-2- ^{14}C into phytol produced by corn leaves.¹²³ Sclareol (CXLIII) is not labeled from MVA in *Salvia officinalis*, but $^{14}CO_2$ was readily incorporated.²⁸⁸ The negative data on sclareol (CXLIII) formation from MVA may indicate that the precursor did not reach the site of biosynthesis.

The most complete biosynthetic studies on diterpenoid compounds have been those on rosenonolactone (CXLIV in Fig. 20)^{66, 79} and the gibberellins (CXLV in Fig. 20).^{65, 66, 124, 125, 159, 175, 325, 328, 329, 401, 416} Both compounds have modified diterpene carbon skeletons. The English⁶⁶ and Swiss⁷⁹ groups obtained the same results, independently, on the biosynthesis of rosenonolactone (CXLIV) produced by the same organism as produces the sesquiterpenoid trichothecin, from acetate-1- ^{14}C and MVA-2- ^{14}C , in which they found the pattern of labeling that would be expected from the normal isoprenoid biosynthesis pathway. Of particular importance was the finding by both laboratories that no randomization of label occurred in the terminal methyl carbon atoms of GGPP (XXI) (the methyl group of ring A was labeled, but no label in the carbon from the lactone ring was

† For example, we have found a complex mixture consisting of at least ten diterpenoid alkaloids in *Delphinium ajacis* leaves and ten or more different alkaloids in the flowers, most of which remain unidentified.

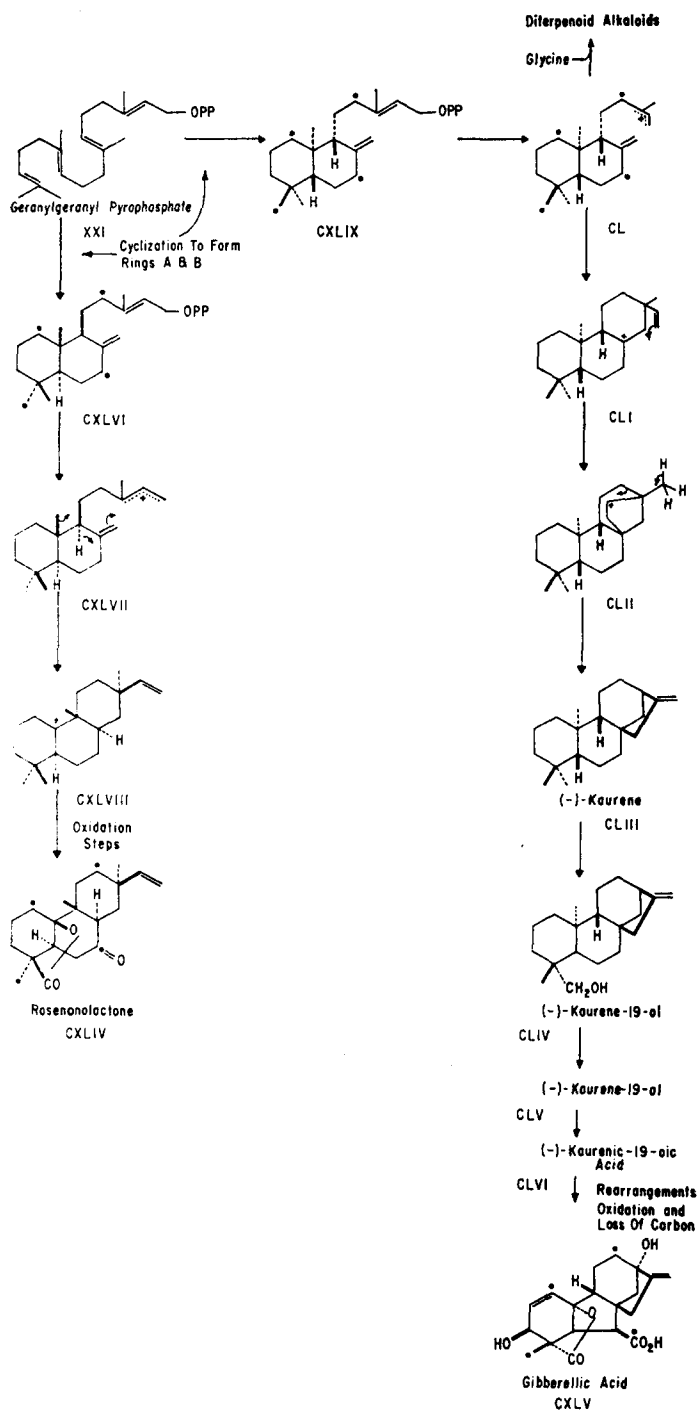

FIG. 20. Biogenesis of the enantiomorphous diterpenoids.

found). In the biosynthesis of gibberellic acid (CXLV)^{65, 66} by the fungus *Gibberella fujikurui*, a pattern of labeling was found which was similar to that of rosenonolactone (CXLIV). Again, when MVA-2¹⁴C was the precursor, the lactonic-carbon of ring A was labeled; thereby, the results on the biosynthesis of gibberellic acid (CXLV) were in full agreement with those obtained on rosenonolactone (CXLIV).

The biogenesis of these two diterpenoids must be considered separately, as the gibberellin series are enantiomorphic with the "normal" diterpenes, so the precursors must be the mirror-images of each other. The biogenesis of each of these diterpenoids from geranylgeranylpyrophosphate (XXI) is shown in Fig. 20.

Cross *et al.*¹²⁵ first suggested the structural relationship of gibberellic acid (GA) to diterpenes and later demonstrated the conversion of ¹⁴C-labeled (–)-kaurene (CLIII) to GA.¹²⁴ Cell-free homogenates of the endosperm nucellus of the seed of *Echinocystis macrocarpa* (wild cucumber) convert MVA-2-¹⁴C to (–)-kaurene (CLIII), (–)-kaurene-19-ol (CLIV), (–)-kaurene-19-al (CLV), (–)-kaurenic-19-oic acid (CLVI), and *trans*-geranylgeraniol (CXI) in the presence of ATP.^{175, 416} This reaction is localized in the microsomal pellet and requires the addition of either a reduced pyridine nucleotide or a heated 105,000 × *g* supernatant fraction; it also requires air. In addition, 7-β-hydroxy-(–)-kaurenic-19-oic acid has been tentatively identified;⁴¹⁶ however, it is not clear if this is an intermediate in the biosynthesis of gibberellins. In contrast, homogenates of the wild cucumber embryo did not catalyze the formation of these diterpenoids from MVA and ATP, but rather squalene (CLXV) and farnesol (CXVIII) were formed. This finding is of interest since it indicated that MVA metabolism in the endosperm nucellus may be directed to diterpenoid biosynthesis while that of the embryo from the same seed may be directed to the synthesis of triterpenoids. Kaurene-¹⁴C (CLIII) and kaurenol-¹⁴C (CLIV) were incorporated into gibberellic acid (CXLV) in washed suspensions of *Fusarium moniliforme*, providing confirming evidence for the role of these compounds as intermediates; however, *trans*-geranylgeraniol-2-¹⁴C (CXL) did not give rise to gibberellic acid (CXLV) and was therefore considered not to be a likely biosynthesis intermediate. Cell-free studies with germinating *Ricinus communis* (castor bean) seeds have confirmed the formation of (–)-kaurene (CLIII) from MVA-2-¹⁴C in the presence of ATP; and, in addition, it was shown that squalene (CLXV) and three diterpene hydrocarbons—tentatively identified as stachene, (+) sandaracopimaradiene, and trachylobane³²⁵—were found.† The cycliza-

† The structures of these diterpene hydrocarbons are shown below. Dr. West has stated that their enzyme studies indicate that at least four different cyclization enzymes are involved in the formation of these three diterpenes, (–)-kaurene (CLIII) and squalene (CLXV). The biosynthesis role and function of these diterpene hydrocarbons is not known.

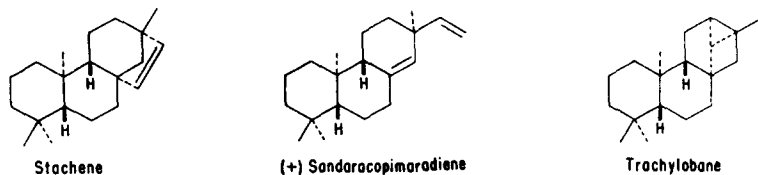

tion of GGPP to (–)-kaurene is catalyzed by the 105,000×g supernatant fraction of the endosperm of wild cucumber seeds (this enzyme system is named kaurene synthase by West⁴¹⁶). The kaurene synthase has a sharp pH optimum at 6.6 and requires divalent metal ions. (–)-Kaurenic-19-oic acid (CLVI),¹⁵⁹ and (–)-kaurenol (CLIV)⁴⁰¹ serve as precursors of gibberellins in cultures of *Gibberella fujikora*. Evidence for an intermediate step in the pathway to gibberellic acid [(CXLV) (GA-3)] was obtained by the Geissman group⁴⁰¹ by the observation that a radioactive GA-4 + GA-7 fraction from a (–)-kaurenol-fed culture could give rise to GA-3 when fed to a second culture.

The biosynthesis of steviol (CLVII), a diterpene aglycone obtained from stevioside, which is produced by *Stevia rebaudiana* (a South American shrub) and is responsible for the extraordinarily sweet taste of the leaves, has been studied.³²⁸ No label was detected in steviol (CLVII) when MVA-2-¹⁴C was used as a precursor, but label from acetate-2-¹⁴C was incorporated into the diterpene. The negative result obtained with MVA is probably due to the lack of MVA-¹⁴C to get to the site of biosynthesis. The Heftman group considered that steviol (CLVII), which has a similar stereochemical configuration to that of kaurene (CLIII), might also serve as a precursor for the gibberellins [(CXLV) GA-3 specifically].³²⁹ Steviol-¹⁴C (CLVII) was converted to a gibberellin-like compound by *F. moniliforme*, but no gibberellins of known structure were labeled.

The biosynthesis of marrubinin (CLVIII) by *Marrubium vulgare* (white horehound) from several ¹⁴C labeled precursors indicated that the diterpenoid

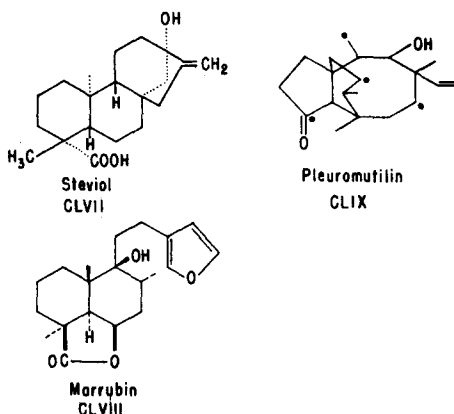

undergoes a rapid turnover and that the biological half-life is about 24 hours.⁷⁸ MVA-2-¹⁴C was the most efficient precursor studied—results which are in contrast with the formation of monoterpenes by peppermint.²⁴⁹ Partial chemical degradation of marrubinin (CLVIII) provided the expected labeling pattern.

An elegant example involving the use of tracer experiments is the biosynthesis

study of pleuromutilin (CLIX) of *Pleurotus mutilus*, which also aided in the elucidation of the structure^{60, 62} of this complex diterpenoid. The labeling pattern as shown was rationalized on the basis of its derivation from geranylinalool (CXLI).¹⁸

The diterpenoid alkaloids represent a particularly interesting group of compounds since their stereochemistry at the A/B ring junction is enantiomorphic to that usually encountered, and, consequently, places them on the same general biosynthesis pathway from GGPP (XXI) as the gibberellins. Although there has been much speculation concerning the biosynthesis of the diterpenoid alkaloids, there are only three reports of biosynthesis experiments. In the first of these, Herbert and Kirby²⁰⁸ failed to obtain incorporation of mevalonate-2-¹⁴C into delpheline, a diterpenoid alkaloid with the lycocotinine skeleton, in detached leaves of *Delphinium elatum*. Benn and May⁴⁵ using intact plants of *Delphinium brownii* obtained low incorporation of acetate-1-¹⁴C and -2-¹⁴C as well as mevalonate-2-¹⁴C into brownine (CLX) and lycocotinine (CLXI), a related alkaloid with the lycocotinine skeleton. Recently, the biosynthesis of the alkaloids ajaconine (CLXII), delcosine (CLXIII), and O-acetyldelcosine

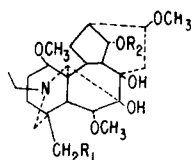

CLX $R_1 = \text{OCH}_3$, $R_2 = \text{H}$; BROWNINE

CLXI $R_1 = \text{OH}$, $R_2 = \text{CH}_3$; LYCOCTONINE

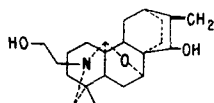

AJACONINE
CLXII

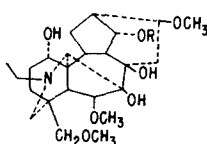

CLXIII $R = \text{H}$; DELCOSINE

CLXIV $R = \text{COCH}_3$; ACETYLDELCOSINE

(CLXIV) (all alkaloids with the lycocotinine skeleton) from *Delphinium ajacis* (larkspur) were studied using MVA-2-¹⁴C and glycine-2-¹⁴C as precursors.¹⁵⁶ Although the extent of incorporation was low, the results support and extend the previous positive finding on the incorporation of MVA into the lycocotinine-type alkaloids. It seems likely that glycine is the precursor of the N-ethyl side chain. The biogenetic relationship of these compounds to the diterpenes is indicated in Fig. 20.

F. Triterpenoids and steroids

Squalene (CLXV) can be formed by the head-to-tail condensation of two moles of FPP as shown by Lynen *et al.*²⁵⁷ and Popják *et al.*^{304, 305} Beeler

*et al.*⁴³ have demonstrated its formation enzymically from carrot and tomato extracts. Squalene (CLXV) is a key precursor of steroids in both plant and animal systems and in the formation of the cyclic triterpenoids.

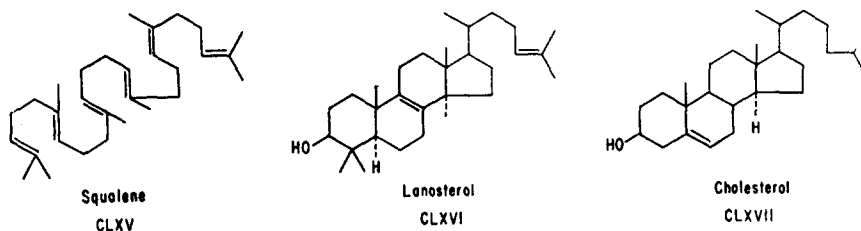

Although squalene (CLXV) is a symmetrical molecule, it was recognized in 1961 by Popják *et al.*,^{308, 305} that its two halves were derived from two farnesyl residues in different ways. There are $2^{14} = 16,384$ possible stereo-isomers that can be formed from the six molecules of MVA (XI) used in the biosynthesis of squalene.^{120, 302} The fact that nature uses only one of these paths is quite remarkable. Popják and Cornforth³⁰² have summarized in their Ciba Medal Lecture in 1966 the results of a classical series of experiments using specifically labeled (a) NADPH (NADH can also serve as an electron donor) and MVA that reduces the possible stereospecific biosynthetic pathways from 16,384 to 2, and (b) deuterated or tritiated R and S mevalonic acids† to show the stereospecificity involved in the elimination of the hydrogen atoms.

It is beyond the scope of this review to describe either these studies or the recent information on the cyclization of squalene (CLXV) to lanosterol (CLXVI)^{31, 118, 119, 399} (see also the review articles cited in the introduction) that lead ultimately to the formation of cholesterol (CLXVII).^{119, 425} Presumably the reactions in the animal and plant systems are analogous, although the latter has certainly not been verified since it has been only recently that cholesterol (CLXVII) has been found in plants.

Ruzicka³³⁷ has recently reviewed the biogenesis of all of the major classes of cyclic terpenes with emphasis placed on testing the hypothetical mechanisms of their formation by the use of appropriately labeled biological precursors.

† R and S refer to the description of absolute configuration around asymmetric carbon atoms as proposed by Cohn, Ingold and Prelog (*Experientia* 12, 81 (1956)). According to this system, the substituents on an asymmetric carbon atom are arranged in a priority order according to decreasing atomic numbers, and for the same atomic number according to decreasing atomic weights. If, on viewing the molecule from a direction opposite to the substituent of the lowest priority, the priority order of the other three groups decreases in the clockwise direction, the absolute configuration is said to be R, otherwise it is S. This system is particularly suited for the description of an asymmetry created by isotopic labeling.

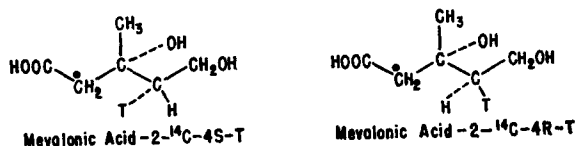

The most exhaustive and complete work on triterpenoids through 1963, including aspects of biosynthesis and bioconversion, is the book by Boiteau *et al.*⁷¹

The squalene \rightarrow tetracyclic triterpene hypothesis received strong support from biosynthesis experiments conducted on the fungus metabolite, eburicoic acid (CLXVIII).^{127, 128} The labeling pattern obtained with eburicoic acid produced by *Polyporus anthrocophilvi* from acetate-1-¹⁴C was consistent with the cyclization of squalene to form this triterpenoid. Formate¹²⁸ and the S-methyl of adenosylmethionine has been shown to be the precursor of the "extra" C-28 methylene carbon atom of triterpenoids and plant steroids (see also refs. 24, 103, 402). Only two protons of the "extra" methyl were incorporated.^{163, 212} Recently it was shown that 24-methylenedihydrolanosterol could serve as a precursor of eburicoic acid.³⁰

Proof that the methyl carbons in the terminal isopropylidene group of squalene retain their individual identity in the course of cyclization was obtained by Arigoni,¹⁷ who studied the biosynthesis of soyasapogenols (from soya-bean) from MVA-2-¹⁴C. Chemical degradation of soyasapogenol D (CLXIX) showed that practically none of the carbon-14 label was found in the axially oriented hydroxymethyl group [C-24] at C-4 and it was concluded that this carbon

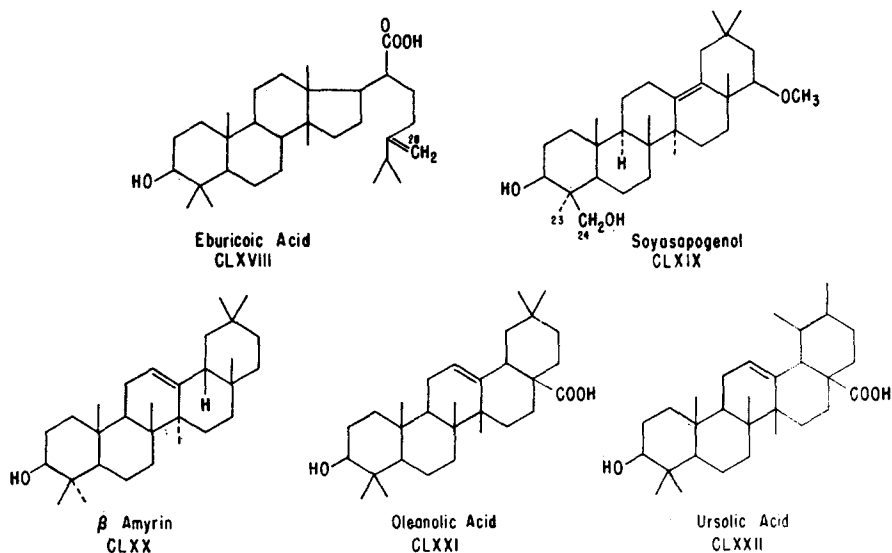

must originate from the methyl carbon of MVA (since the label must be in the equatorial methyl carbon, C-23). This finding was of considerable importance because it aided in establishing the stereospecificity of the polymerization of IpPP (XVI) and DmaPP (XVIII).

It now appears that cholesterol (CLXVII) is probably as widely distributed among plants as it is among animals.^{49, 53, 133, 214, 215} The estrogenic hormones progesterone (CLXXXII),²³⁵ estrone^{53, 197, 198} and pregnenolone (CLXXXVII)^{50, 101, 148, 395} have recently been found in plants.

MVA is incorporated into squalene (CLXV),⁹⁵ β -amyrin (CLXX)²⁵ by *Pisum sativum* (pea); into β -sitosterol (CLXXVII), oleanolic acid (CLXXI), and ursolic acid(s) (CLXXII) by *Salvia officianalis*;^{279, 280, 286} into squalene, acidic triterpenes and steam-volatile terpenes by cuttings of *Ocimum basilicum*;²⁸¹ into Δ^{22} -stigmasten- 3β -ol by *Dictyostelium discoideum* (slime mold);²¹⁶ into sterols and sapogenins by *Dioscorea spiculiflora*;⁵² into β -sitosterol by *Rawolfia serpentina*;⁴¹ and into digitoxigenin (CLXXXVIII) by *Digitalis purpurea*.^{182, 289} Differences in the extent of incorporation of precursor into products was observed. It is of interest to note that 21 per cent of the MVA- $2\text{-}^{14}\text{C}$ was incorporated into ursolic acid (CLXXII)²⁸⁶ and generally, in the series of experiments mentioned above, the efficiency of incorporation into pentacyclic triterpenes was higher than that into β -sitosterol (which has an ethyl group in the sidechain, rather than a methyl group which is the normal structure). MVA- $2\text{-}^{14}\text{C}$ is incorporated into β -sitosterol (CLXXVII) and β -amyrin (CLXX) by cut flower stalks of *Taraxacum officinale* (dandelion) and the results obtained by radio-gas-chromatography indicated a number of possible sterol intermediates, but were inconclusive with respect to lanosterol (CLXVI).² In tissue culture studies used for the biosyntheses of phytosterols, it was first suggested⁵⁶ and later proven experimentally¹⁴¹ that the triterpene cycloartenol (CLXXIII) may take the place of lanosterol (CLXVI) in the sequence squalene \rightarrow phytosterols. Such a biogenetic pathway for β -sitosterol (CLXXVII) has been proposed.^{2, 141} The formation of β -sitosterol apparently occurs by alkylation of an as yet unidentified

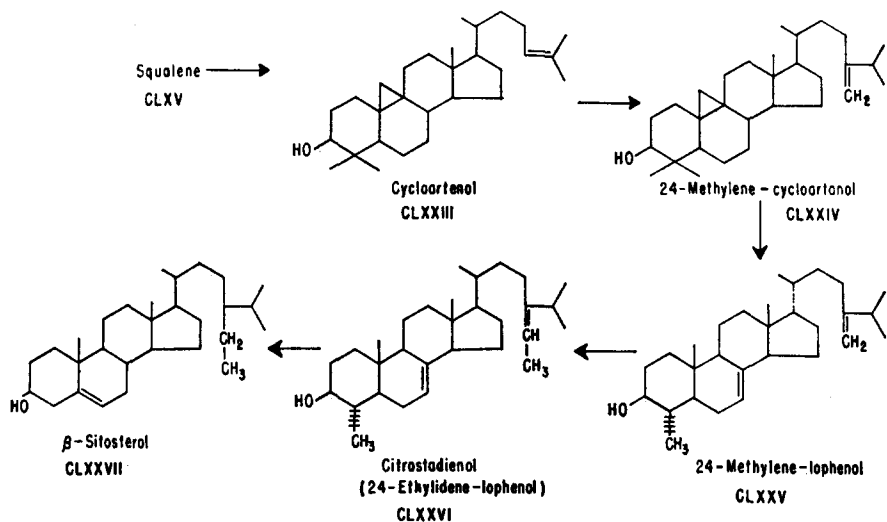

FIG. 21. Biogenesis of β -sitosterol from squalene.^{2, 141}

precursor^{162, 237, 277, 318} by the methyl group of methionine^{103, 402} but more definite experiments to clarify the methyl-acceptor molecule are required.

The origin of the ethyl sidechain in the phytosterol spinasterol (CLXXX) produced by *Menyanthes trifoliata*† is the methyl of methionine and presumably

† *M. trifoliata* also produces loganin (CCXXX).

is the result of a double alkylation process (CLXXVIII \rightarrow CLXXIX \rightarrow CLXXX) (Fig. 22)²⁴ using a zymosterol-type sidechain (CLXXVIII) as a precursor and a 24-methylene derivative (CLXXIX) as an intermediate.

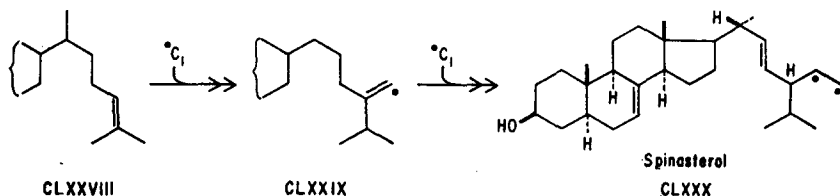

Fig. 22. The origin of the ethyl sidechain of spinasterol.²⁴

Squalene serves as the precursor of β -sitosterol (CLXXVII) in *Pharbitis nil* seedlings⁴⁷ and for the pentacyclic triterpenoid, β -amyrin (CLXX), in cell-free extracts of *Pisum sativum*.⁹⁶

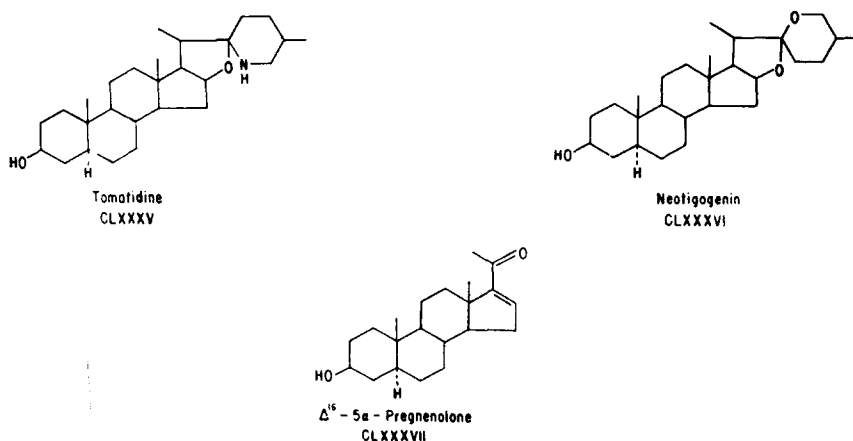
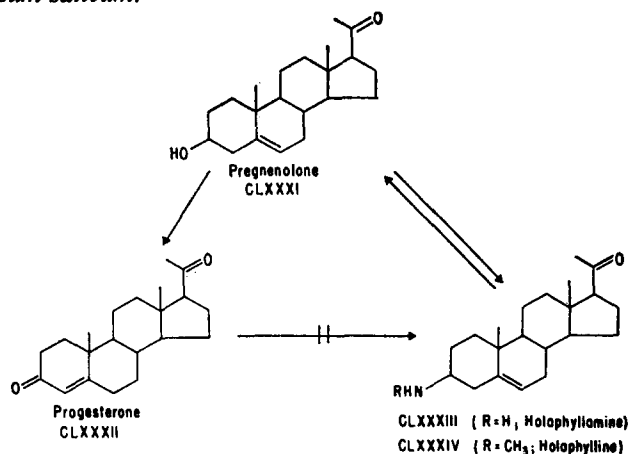

FIG. 23. Plant steroids biosynthesized from cholesterol. The top half of the figure shows the inter-relationship between the estrogenic hormones and the steroidal alkaloids of *Holarrhena floribunda*, all of which are derived from cholesterol.

Both cholesterol (CLXVII) and progesterone (CLXXXII) serve as precursors of the alkaloids from *Holarrhena floribunda* (an African plant).⁴⁶ The steroidal alkaloids holaphyllamine (CLXXXIII) and holaphylline (CLXXXIV) were labeled by cholesterol-4-¹⁴C, whereas progesterone-4-¹⁴C (CLXXXII) labeled unidentified basic compounds; radioactive pregnenolone (CLXXXI) was not detected.⁴⁶ A reversible condition exists between pregnenolone (CLXXXI) and holaphyllamine (CLXXXIII) and was demonstrated (Fig. 23) by the finding that holaphyllamine-4-¹⁴C (CLXXXIII) could serve as a precursor of pregnenolone (CLXXXI) in *H. floribunda*.⁵¹ Cholesterol (CLXVII) can serve as a precursor of pregnenolone (CLXXXI) in *Haplopappus heterophyllus* (golden rod).⁴⁹

Pregnenolone (CLXXXI) is a precursor of cardenolides³⁹⁴ and bufadienolides.³⁹²

The Heftman group have recently shown that cholesterol-4-¹⁴C can serve as a precursor of the steroidal alkaloid tomatidine (CLXXXV), the structurally analogous sapogenin neotigogenin (CLXXXVI) and Δ^{16} -5-pregnen-3 β -ol-20-one (CLXXXVII) in *Lycopersicon pimpinellifolium* (tomato).^{55, 199} They conclude that the biosynthetic pathways of tomatidine and neotigogenin coincide as far as cholesterol. The biosynthesis of Δ^{16} -5-pregnenolone from cholesterol supports the finding that the latter compound is a precursor of the isomeric- Δ^5 -pregnen-3 β -ol-20-one in *Haplopappus heterophyllus*⁴⁹ and *Digitalis purpurea*.¹⁰² as well as of all pregnone derivatives in animals. Cholesterol can also serve as a precursor of sapogenins from *Dioscorea speculiflora*⁴⁸ and *Digitalis lanata*.³⁹³

From the very interesting role of cholesterol (CLXVII) as a precursor of the plant sterols (Fig. 23) it may be concluded that the steroids (triterpenoids) in plants are in a dynamic state. Clarification of the details involved in some of these biological reactions will be awaited with much interest.

It is of interest that carbons 22 and 23 in digitoxigenin (CLXXXVIII) biosynthesized from MVA-2-¹⁴C did not originate from the precursor, whereas

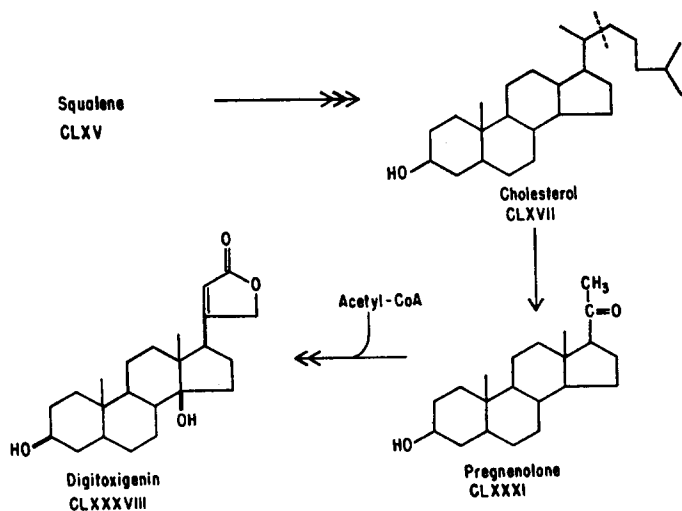
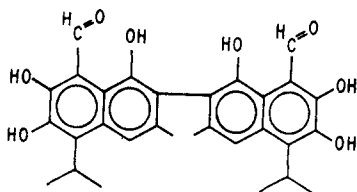

FIG. 24. Biogenesis of digitoxigenin.¹⁸²

when acetate-1-¹⁴C was the precursor, C-23 was labeled. The Leete group^{182, 239} concluded that the initial step in the conversion of cholesterol to butenolides could be cleavage between C-20 and C-22 to yield pregnenolone (CLXXXI) or a similar C₂₁-20-ketone (Fig. 24). Subsequent addition of a two-carbon compound such as acetate could then give rise to the butenolide sterols. Support for this was obtained by Caspi *et al.*,¹⁰² who showed that cholesterol could be transformed into pregnenolone by *Digitalis purpurea*.

Gossypol (CLXXXIX),¹ a triterpene polyphenolic pigment which exists in three tautomeric forms, has been established as the toxic principle of cotton seed meal. It is found primarily in the seed pigment gland,²⁹⁹ which may constitute up to 2 per cent of the weight of the seed. The investigations of Boatner and co-workers^{69, 70} revealed that the pigment glands consist of a "firm-walled sac filled with colloidal amorphous material" which contains approximately 50 per cent gossypol. A group of pigments structurally related to gossypol, but lower concentration, were also found in the seed pigment gland.²⁵⁴

Gossypol (CLXXXIX) appears to be an exception to the rule^{167, 379} that all triterpenes or triterpenoid compounds found in nature must originate from squalene (CLXV). The formation of gossypol through a thirty-carbon hydrocarbon would require an intermediate different from squalene in that linkage



Gossypol
CLXXXIX

at the C-2 position of the fifteen-carbon intermediate would be required. The alternative to the route involving a thirty-carbon hydrocarbon intermediate would be cyclization of the fifteen-carbon intermediate, reduction to an aromatic ring, and oxidation before condensation to a precursor of gossypol.

Smith³⁶⁸ showed that a net synthesis of gossypol (CLXXXIX) occurred in excised cotton roots from both glanded and nonglanded strains of cotton. This observation indicated that the enzyme system required for the complete biosynthesis of gossypol was in the cotton root. Heinsteins *et al.*²⁰⁰ reported a high incorporation of acetate-¹⁴C into gossypol with excised cotton roots. Cotton root homogenates were also capable of synthesizing gossypol from either acetate-¹⁴C or MVA-2-¹⁴C. About 22 per cent incorporation of the biological active isomer of DL-MVA-2-¹⁴C was reported with the complete cotton root homogenate system.

Recently Heinsteins^{200a} found that the incorporation of geranyl-2-¹⁴C pyrophosphate (XIX) into gossypol by a cotton root homogenate was equal to the incorporation of MVA-2-¹⁴C, whereas neryl-2-¹⁴C pyrophosphate (XXIIIa) was twice as efficient as MVA-2-¹⁴C. From chemical degradation, it was concluded

A proposal for the biogenesis of gossypol involving *cis-cis* FPP (CXC) is shown in Fig. 25.^{1, 200a, 288}

Chain elongation of IpPP proceeds to form nerylpyrophosphate (XXIIIa), which is followed by the formation of first an acyclic sesquiterpenoid intermediate which most likely is *cis-cis*-FPP (CXC) (since *trans-trans*-FPP is not a precursor and is also based on the gossypol labeling pattern from XXIIIa). The first aromatic intermediate formed from the acyclic sesquiterpenoid (CXC) is 2-[2-methyl-butyl'-3-isopropyl-6-methyl phenol (CXCI), which can give rise to the proposed naphthyl precursor (2-cadalenol, CXCII) of gossypol (CLXXXIX). Dimerization by oxidative coupling at the ortho position of the α -naphthol derivative CXCII would be expected to yield the 2,2'-binaphthol derivative CXCIIa. The proposed precursor role of 2-cadalenol (CXCII) is both an extension of the recognition of the cadalene dimeric structure of gossypol^{29, 336, 337} (CLXXXIX) and a logical compound to be formed from the known precursor CXCI. The specific precursor on which hydroxylation and formation of the formyl group occurs (before or after oxidative coupling) to produce gossypol (CLXXXIX) remains unknown.

G. Tetraterpenes: carotenoids

Several reviews of this very extensively studied subject area have appeared in recent years,^{43, 91, 109, 168, 170, 213, 410} consequently, a section is included in this chapter only for completeness and for the purpose of bringing the reader up to date on the most recent findings. The carotenoids, tetraterpenes, and their derivatives are ubiquitous in the plant kingdom and occur in all tissues, but are found in highest concentration in the chloroplast. The carotenes are hydrocarbons, and the xanthophylls are their oxygenated derivatives; they are major constituents of the yellow pigments obtained from leaves, flowers, and fruits. There is no evidence that carotenoids can be synthesized by animals.

Studies on β -carotene (CXCIII) biosynthesis in *Mucor hiemalis*,^{178, 179, 180} *Pycomyces blakesleeanus* and carrot slices,^{76, 256} and *Euglena gracilis*³⁶⁸ demonstrated that acetate-¹⁴C was incorporated in a manner consistent with the mevalonate pathway (Fig. 26).

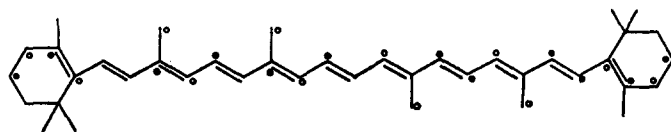

CXCIII

FIG. 26. The distribution of acetate-1-¹⁴C (●) and acetate-2-¹⁴C (○) in β -carotene.

It is now generally accepted that phytoene (CXCIV) is the first C₄₀ carotenoid formed. A wide variety of experiments were conducted which showed phytoene (CXCIV) rather than other carotenoid hydrocarbons was found to accumulate.¹⁶⁸ The formation of the C₄₀ terpene hydrocarbon probably proceeds by the

head-to-tail condensation of two units of geranylgeranylpyrophosphate (XXI).¹² The latter compound labeled with ¹⁴C has been found to be incorporated into phytoene in a carrot plastid system^{129, 414} and recently phytoene formation from IpPP and FPP by a partially purified tomato enzyme system was shown.^{219a} From results obtained from the dilution of radioactivity from acetate-¹⁴C and MVA-2-¹⁴C in metabolic competition experiments, geranylinalool (CXLI) has

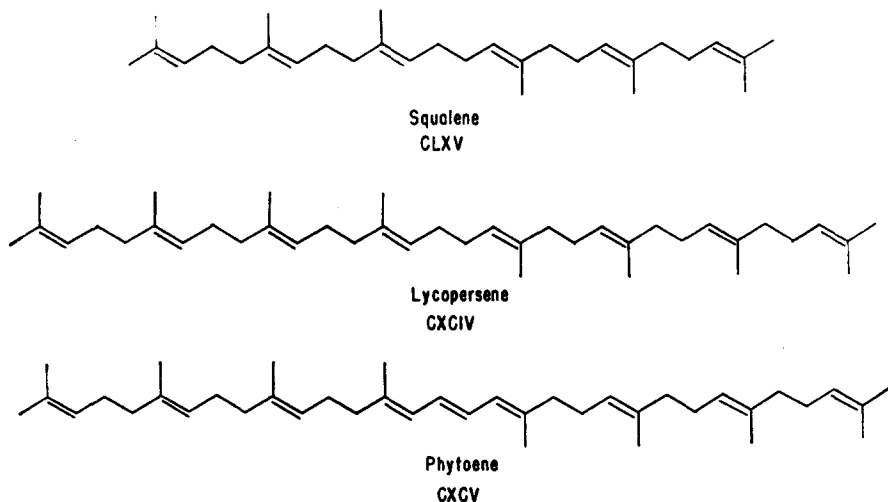

been implicated as a precursor of carotenoids in much the same manner as was geranylgeraniol (CXL), whereas phytol (CXLII) is not active.²⁸³ The condensation reaction between 2 moles of GGPP (XXI) does not appear to be analogous with that of squalene (CLXV) formation from two units of farnesylpyrophosphate (XX), since the C₄₀ homologue lycopersene (CXCIV) would be produced if this were the case; but it has been shown not to be the first product involved in the biosynthesis of carotenoids.^{129, 268} An important difference between the condensation of two GGPP (XXI) units and the condensation of two FPP (XX) units is that no NADPH is required in the C₂₀ dimerization process;¹² conse-

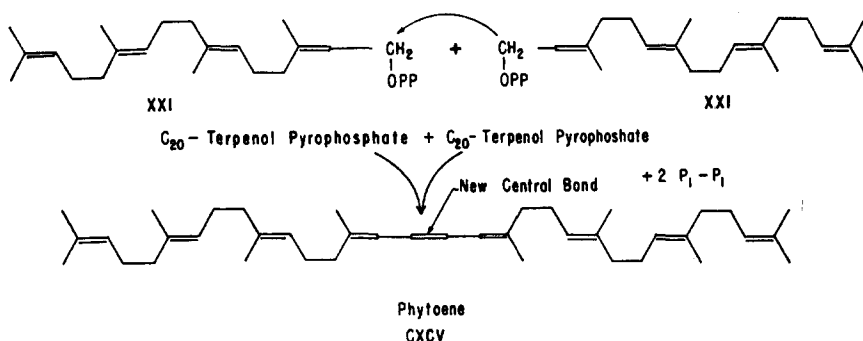

FIG. 27. Union of two molecules of C₂₀-terpenol pyrophosphate to form phytoene. The latter contains a central double bond.

quently, no reduction is involved in the reaction. It has been pointed out^{109, 168} that the central double bond of phytoene (CXCIV), which is absent in lycopersene (CXCIV) (Fig. 27), is in conjugation with the two double bonds of the two central isoprene residues, and would prevent its folding similarly to squalene (CLXV); thus, extensive cyclization initiated by OH^- or H^+ should not be possible. This offers a possible explanation for the absence of fused polycyclic tetraterpenoids in nature analogous to the cyclic triterpenoids of plants. The additional unsaturated linkage in phytoene (CXCIV) places it at least one step closer to the next carotenoid, phytofluene (CXCVI), which is formed by dehydrogenation. The steps involved in the conversion of phytoene to other

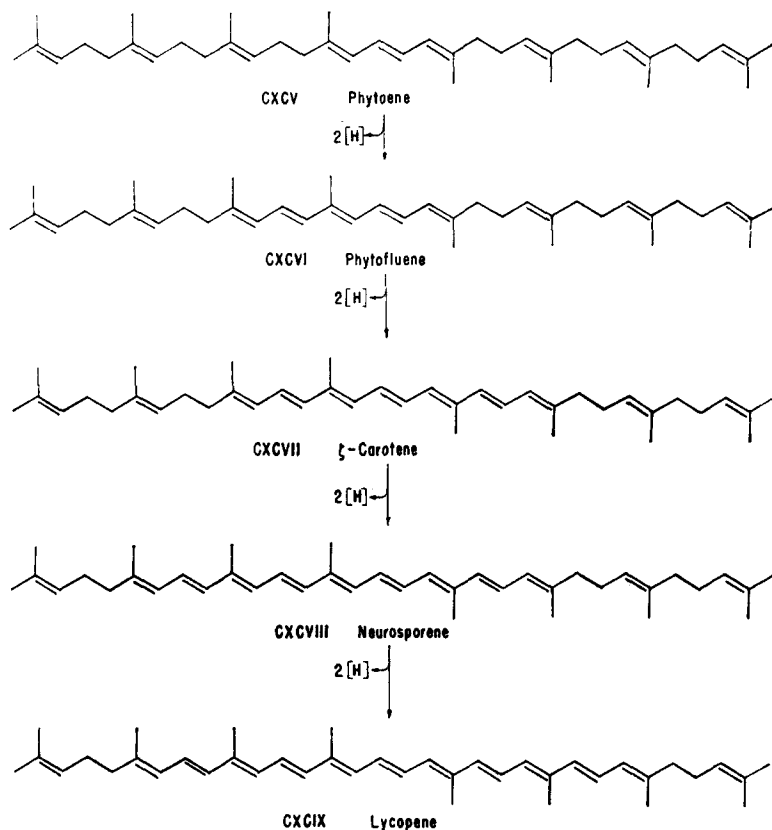

FIG. 28. The pathway of conversion of phytoene into lycopene.

non-cyclic tetraterpenoids are shown in Fig. 28. Phytoene is dehydrogenated in successive steps to form phytofluene (CXCVI), ζ -carotene (CXCVII), neurosporene (CXCVIII), and lycopene (CXCIX). The first step, phytoene to phytofluene, can be carried out by isolated plastids.⁴⁴ Support for the remainder of the sequence is based largely on studies using ripening tomatoes injected with MVA-2-¹⁴C in which the specific activities of the isolated intermediates were consistent with the proposed scheme shown in Fig. 28.^{311, 312}

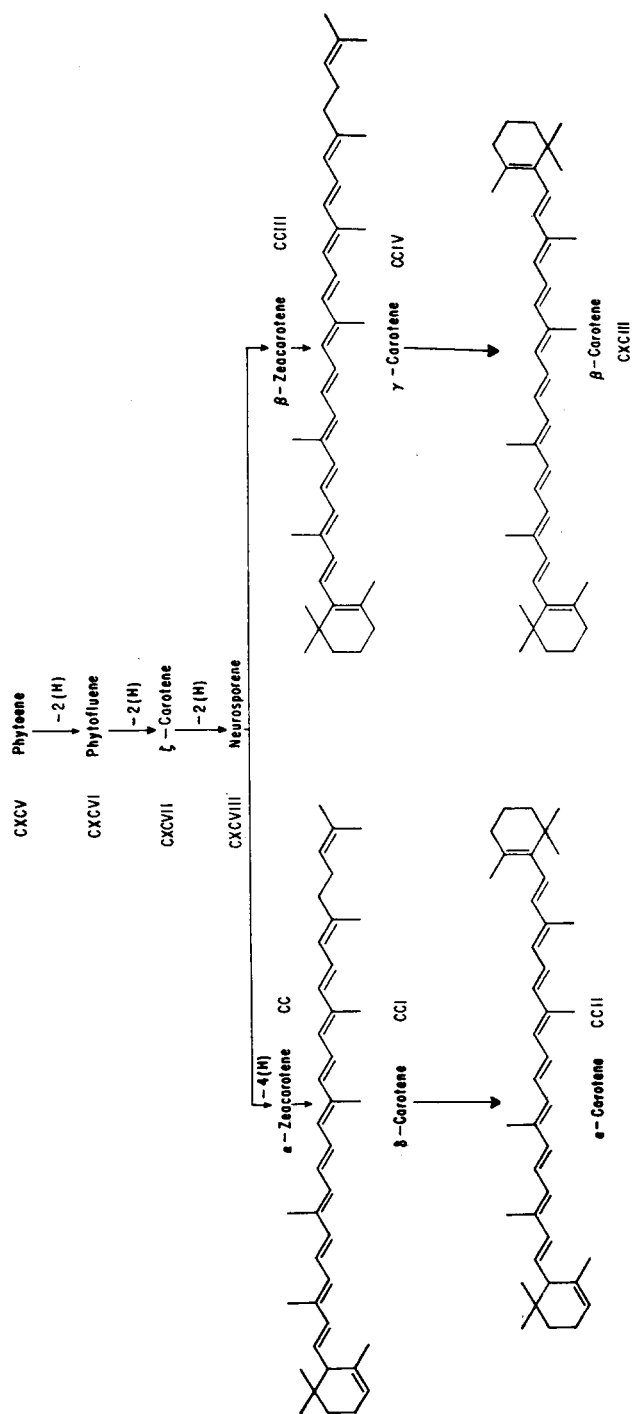

FIG. 29. The biogenesis of mono- and bicyclic carotenoids from phytoene.

The cyclization process involved in forming the carotenoids remains unclear. Lycopene (CXCIX) is not readily converted into β -carotene (CXCIII);⁷³ phytoene-¹⁴C is converted into β -carotene-¹⁴C by cell-free extracts of *Sporobolomyces shibata*.²²⁰ Cyclization is probably hindered by the steric hindrance of the terminal methyl groups and is thought to occur prior to the formation of lycopene. The support for this concept comes from *in vivo* experiments where the specific activity of β -carotene (CXCIII) is often greater than that of lycopene (CXCIX); so it is not likely that the latter is a precursor of the former.^{311, 312} A general biogenetic pathway is shown in Fig. 29, but the exact relation between the series of compounds remains uncertain.

The recent report that β -ionone vapor stimulates the incorporation of MVA-2-¹⁴C into carotenes and high counting non-saponifiable fractions in carrot root slices is not readily explainable.²⁵² Lowry and Chichester also point out a vexing problem in any metabolism study—namely, the demand for rigorous purification of the compound isolated from a natural source, i.e., when phytoene-¹⁴C was incubated with lyophilized carrot slices, the α - and β -carotene bands of non-crystallized α - and β -carotene were highly labeled, but after recrystallization the specific activity fell to zero.^{252†}

Goodwin and Williams¹⁷² have studied the stereochemistry involved in lycopene formation using the tritiated 4R-mevalonate and 4S-mevalonate described previously.‡ They found that the T/¹⁴C ratio in phytoene formed from the 4R-mevalonate by carrot root slices was identical with that of the starting material (which showed that each isotope was present at eight positions in the molecule), whereas no tritium was retained when 4S-mevalonate was used, indicating that the 4R hydrogen is specifically retained. Similar results were obtained from squalene formed by carrot roots and they are in agreement with those for squalene synthesized by rat liver homogenates.³⁰²

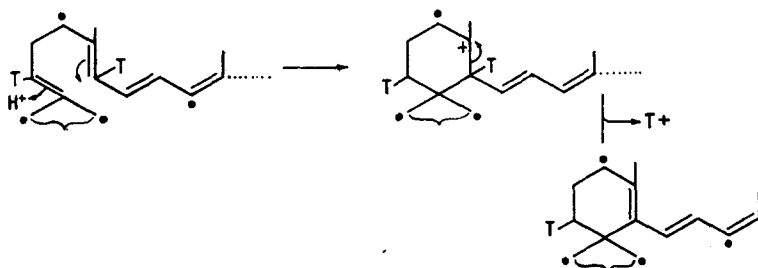

FIG. 30. Possible mechanism for the cyclization of an acyclic precursor to give the β -ionone ring of the carotenoids.¹⁶⁸

The constancy of the T/¹⁴C ratio in phytoene synthesis described above does not hold true for the α -carotene (T/¹⁴C = 7:8) and β -carotene (T/¹⁴C = 6:8).¹⁷¹ These results showed that β -carotene could not be a precursor of α -carotene

† We have encountered the same difficulty in biosynthesis studies of diterpenoid and monoterpenoid alkaloids. On occasions when it is difficult to crystallize a compound, we have had to subject certain compounds to at least twenty TLC runs using various solvents to get material that possessed a constant specific activity.

‡ See note, p. 187.

(Fig. 30) and that the opposite could not occur either. Rather, the loss of one tritium atom occurs for each ring formed.

Formation of the xanthophylls appears to involve oxygenases and occur by insertion of molecular oxygen and not water; however, water can serve as the

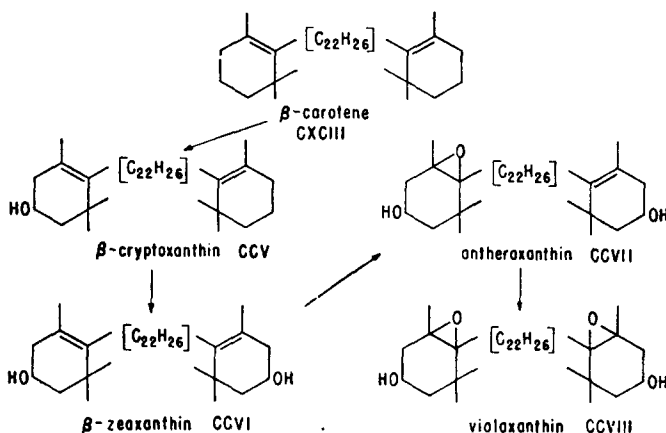
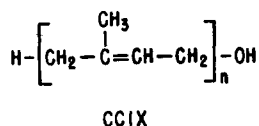

FIG. 31. Oxidized carotenoids derived from β -carotene.

source of the oxygen in the epoxy groups of violaxanthin. This is probably one of the last steps in the biosynthetic sequence.^{142, 355, 428} Illustrative examples of the xanthophylls which can be derived from β -carotene are shown in Fig. 31.

H. Polyterpenoid alcohols

Increasing interest in this group of polyisoprenoid alcohols (polyprenols) which are found in both plant and animal tissues has developed in recent years. The polyprenols can be represented by the general formula (CCIX) and may vary in chain length from 6 to 20 isoprenoid units (C₃₀ to C₁₀₀). These compounds tend to be a mixture of *cis-trans* polyprenols. Although little has been done on the metabolism of these compounds, it is expected that more attention will be devoted to this subject now that the structures of some of them have been determined.



The first polyprenol to be isolated from leaves of higher plants was solanesol (all-*trans*-nonaprenol; $n = 9$), which was isolated from *Nicotiana tabacum* (tobacco).³²⁷ MVA serves as a precursor of solanesol,^{57, 317} but the extent of incorporation is low. The trivial name, castaneol, was given to a polyprenol preparation ($n = 10, 11, 12$, and 13 ; with $n = 12$ predominating), isolated from

leaves of *Aesculus hippocastanum* (horse chestnut).^{371, 412} In fact, the occurrence of polyprenols is not limited to photosynthetic tissue. The spadix of *Arum maculatum* (lords and ladies) yields a number of these long-chain alcohols.²⁰¹ Wellburn and Hemming⁴¹² indicated that polyprenols may be widespread in higher plants.

A series of polyprenols called betulaprenols, where $n = 6, 7, 8,$ and 9 , has been isolated from the wood of *Betula verrucosa* (silver birch).²⁴³ In the examples cited, other than solanesol and one of the *Arum spadix* polyprenols, all of these prenols have more double bonds of the isoprene residues in the *cis* configuration than in the *trans* configuration.

Dolichol, a C_{100} polyprenol ($n = 20$), is the largest molecular weight compound of this series to be characterized. Dolichol was isolated from pig liver, is present in many mammalian tissues (yeast),⁹⁰ and has been reported to occur in plant tissue.²⁰¹ Fifteen or sixteen of its internal isoprene units have the *cis* configuration. In dolichol, the "OH terminal" isoprene residue is saturated. It can be biosynthesized from mevalonate, but the rate is slow.^{93, 94}

Polyprenols closely related to dolichol have been found in *Saccharomyces cerevisiae* (baker's yeast),⁸⁹ *Aspergillus fumigatus*,⁸⁹ and *Lactobacillus casei* (bactoprenol; $n = 11$).³⁸⁸ The $n = 11$ polyprenol produced by *L. casei* is the major metabolite of mevalonate, although it occurs in low concentration. A terpene phosphate synthetase has been isolated from *Micrococcus liposeiiticus*, which catalyzes the condensation of allylpyrophosphates with IpPP to produce C_{35} and C_{45} terpene pyrophosphates.⁷ An interesting finding was that the terpene pyrophosphate products are bound to the enzyme, but covalent linkages are not involved. This interaction between protein and reaction products was not observed on the GGPP (XXI) synthetase.²²¹

Of considerable interest is the elegant work on characterization of castaprenols† from *Aesculus hippocastanum* (horse chestnut)⁴¹³ and the ficaprenols from *Ficus elastica* (the decorative rubber plant).³⁷² The polyprenols mixture from horse chestnut leaves contains predominantly castraprenol-12 ($n = 12$) with castraprenol-11 and castraprenol-13 being present in smaller amounts, and a trace of castraprenol-10. Each of these compounds contains three *trans* internal isoprene residues and a *cis* "OH terminal" isoprene residue. They differ from each other only in the number of *cis* internal isoprene residues. In the study of polyprenols isolated from *F. elastica*, this group of workers found that ficaprenol-11 ($n = 11$) was the major component with ficaprenols-10 and 12 occurring in lesser amounts and traces of ficaprenol-9 and 13. The castaprenols are found mainly in the chloroplasts; however, upon aging they are also found outside the chloroplast.⁷ They are not found in the wood or bark of the horse chestnut. The Morton group suggest that the ficaprenols-10, 11, 12, and 13 are probably the same compounds. Their proposed biogenesis of this group of polyprenols, which have all three internal *trans* isoprene residues adjacent to

† As mentioned above, the trivial name *castaneol* was given to polyprenols isolated from horse chestnut by Stevenson *et al.*,³⁷¹ but the same group of workers now prefer the trivial name *castaprenol*, which appears to be somewhat more definitive.

the ω -terminal isoprene residue, involves the addition of *cis* isoprene units to all-*trans*-geranylgeranylpyrophosphate (XXI) by the action of a poly-*cis*-synthetase system.

Leaves of the rubber tree, *Hevea brasiliensis*, have been found to contain polyprenols ($n = 11, 12, 13$) with three internal isoprene units in the *trans* configuration and the remainder *cis*.¹³⁹ These polyprenols may be related to rubber biosynthesis, as will be pointed out in the section on rubber.

I. Polyisoprenoid quinones

A large number of polyisoprenoid quinones are found in plants. Among these are: (a) the tocopherols (CCXI and CCXII) are the examples shown (the γ and δ isomers are also known) or vitamins E, a group of partially hydrogenated isopentanoic compounds found in plants and essential for reproduction in some animals, (b) the antihemorrhagic vitamins K (see structure XLIII for

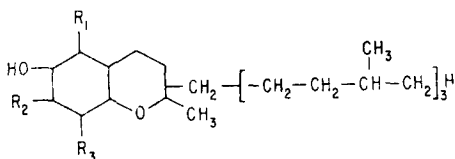

CCXI α -Tocopherol $R_1 = R_2 = R_3 = \text{CH}_3$

CCXII β -Tocopherol $R_1 = \text{CH}_3$
 $R_2 = \text{H}$
 $R_3 = \text{CH}_3$

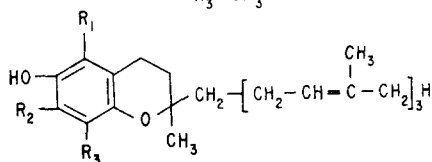

CCXIII α -Tocotrienol $R_1 = \text{CH}_3$
 $R_2 = \text{CH}_3$
 $R_3 = \text{CH}_3$

CCXIV β -Tocotrienol $R_1 = \text{CH}_3$
 $R_2 = \text{H}$
 $R_3 = \text{CH}_3$

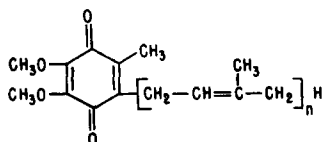

CCXV Ubiquinone

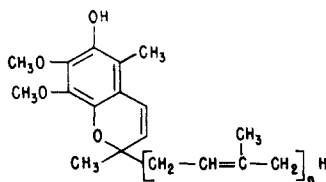

CCXVI Ubichromenol

vitamin K₂), and (c) the ubiquinones (CCXV) (or coenzymes Q) whose significance in metabolism has been only partly evaluated. Related to the ubiquinones are the ubichromenols (CCXVI) which are produced by the condensation of the adjacent isoprene unit with the quinone ring. Much remains to be done on the biosynthesis of the polyisoprenoid quinones. Nicholas²⁸⁴ has very recently reviewed their biosynthesis, metabolism, and physiological functions and the recent book by Morton²⁷⁸ is quite complete. A Ciba Foundation Symposium⁴²⁴ provides many important aspects of the biochemistry of the ubiquinones.

Based on previous knowledge, it seems obvious that MVA can give rise to the side-chain of the polyisoprenoid quinones; but, except for studies on the ubiquinones (CCXV),^{160, 161, 166, 234, 293, 366} convincing experimental proof is lacking. The biosynthesis problem is complicated by compartmentalization within the cell, low level of isotope incorporation, and difficulty in obtaining suitable *in vitro* conditions for systematic enzyme analysis. Confusion still exists

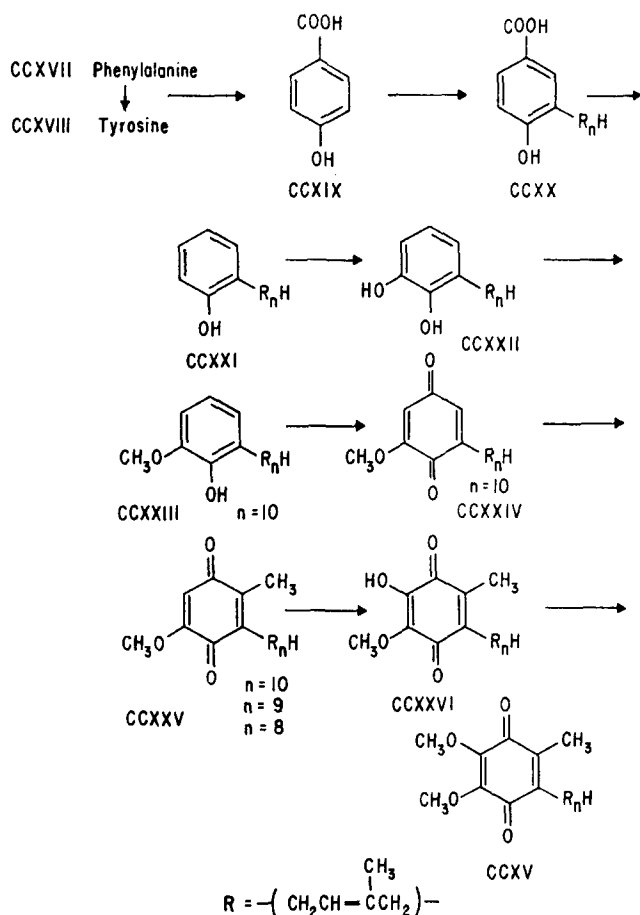

FIG. 32. Biogenetic sequence for the formation of ubiquinones.³⁸⁴

as to whether lengthening of the side-chain while it is attached to the aromatic nucleus or the attachment of the preformed isoprenoid chain to the quinone ring (or its precursor) is most likely, although the evidence^{160, 234, 293, 366} favors the latter approach. In coenzyme Q, biosynthesis of the polyisoprenoid side-chain is believed to occur via the polymerization mechanism described earlier (Fig. 6, page 160), presumably the pre-formed polyisoprenoid side-chain as the pyrophosphate is coupled by nucleophilic attack on the partially substituted aromatic ring.^{160, 234, 293, 366} Since several ubiquinones varying in the number of isoprene residues are found together, it is concluded that different polyisoprenoid units are coupled to the aromatic nucleus by the same tissue—hence, the connection between the polyprenols previously discussed and the polyisoprenoid quinones would seem to be more than just a fortuitous one. Of interest is the finding that *Aspergillus fumigatus* forms the all-*trans*-form of squalene and ubiquinone when MVA-2-¹⁴C-4R-T is the precursor.¹⁶ The methyl and ring methyl carbons of the ubiquinones are derived from formate or from methionine²⁹⁴ and the quinone ring nucleus can be formed from *p*-hydroxybenzaldehyde or *p*-hydroxybenzoic acid (CCXIX).^{292, 297, 334} The most recent biogenesis proposal for the ubiquinones is that of Friis¹⁵⁵ and is shown in Fig. 32.

Considerably less is known about the biosynthesis of the vitamins E (CCXI, CCXII) and K (XLIII) but pathways analogous to that proposed for the ubiquinones¹³⁵ provide logical working hypotheses. The side-chain for the tocopherols is completely hydrogenated; however, several naturally related compounds called tocotrienols (CCXIII, CCXIV which correspond to γ - and β -tocopherol are shown; the γ - and β -isomers are also known) possess unsaturation in the side-chain. Note that in both the tocopherols (CCXI and CCXII) and the tocotrienols (CCXIII and CCXIV) the length of the side-chains is fixed—this is in contrast to the vitamins K (XLIII) and ubiquinones (CCXV).^{266, 273, 424} The biological mechanism that controls the length of the side-chain of the polyisoprenoid quinones as well as that for the polyprenols and rubber is not known. Information on the distribution and concentration in tissues of these polyisoprenoid quinones provides useful hints on biogenesis and this has been summarized elsewhere.²⁸⁴

J. Rubber

Bonner reviewed the progress made on the biosynthesis of rubber in 1963⁷² and 1965⁷³ and Lynen and Henning in 1960.²⁵⁹ About 2000 species of plant produce rubber, but only 500 are considered to be rubber-bearing plants. The production of rubber occurs in the latex of the plant, and the latex is contained in specialized cells. The rubber tree used in commercial operations, *Hevea brasiliensis*, produces the all-*cis* polyisoprenoid isomer, whereas *Palaquium gutta* and *Mimusops balata* produce the all-*trans* isomer (Fig. 33). Some microorganisms produce a *cis*-1,4-polyisoprene and other rubber-like substances.²³³

The *cis*-rubber produced by *H. brasiliensis* is 500–5000 isoprene residues (mol. wt. ranging from 10^5 to 4×10^6) in length, and is unbranched.^{14, 183} It is

not known if functional end groups occur on the molecules, but it is considered to be a hydrocarbon. The polyisoprenoid is insoluble in water and occurs as discrete particles up to 3 microns in diameter in the latex.¹³⁶

The latex of *H. brasiliensis* contains all of the enzymes required for synthesizing rubber from acetate.^{27, 382} Carbon-14 labeled acetate is incorporated into *H. brasiliensis* latex with a specific activity equal to that of the acetate supplied,

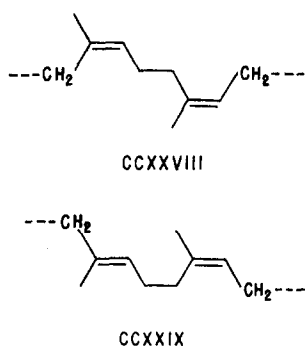

FIG. 33. The two isomeric polyisoprene chains as they occur in rubber and in gutta (top: *cis*-rubber polymer; bottom: *trans*-gutta polymer).

indicating that the transformation of acetate into rubber occurs without great dilution.²⁰ Similar results have been obtained with tissues of the nineteen other plants studied.³⁸³ By incubating the various precursors with latex, it has been shown that mevalonic acid is incorporated into rubber without randomization^{296, 222} of the radioactivity, and similar results were obtained for IpPP.^{15, 259} The conversion of MVA (XI) to IpPP (XVI) occurs in the latex; but the polymerization of the latter precursor takes place *in vitro* almost exclusively on the surface of existing rubber particles,¹⁴ catalyzed by an enzyme which is distributed between the hydrocarbon surface and the aqueous serum. The biosynthesis route is visualized then as proceeding via chain elongation, rather than the initiation of new chains (Fig. 34).

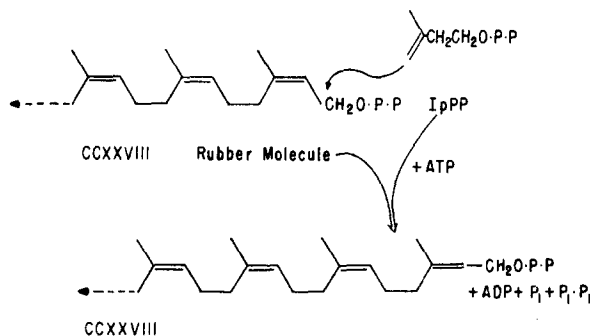

FIG. 34. Diagrammatic sketch representing the growth of the polyisoprene chain by addition of IpPP.

To initiate the formation of new polyisoprenoid chains, all rubber is removed from the latex and the remaining serum is incubated with IpPP (XVI).¹⁴ When IpPP (XVI) is incubated in the presence of the isomeric "starter" DmaPP (XVIII),²⁸ then *trans-trans* FPP (XX) is formed. The addition of the DmaPP (XVIII) was necessary since the enzymic isomerization of IpPP (XVI) could not be detected in latex;³ however, indirect evidence for the presence of the isomerase in *H. brasiliensis* was obtained by showing that the incorporation of mevalonate into squalene was markedly reduced by iodoacetamide.† *Trans-trans* FPP (XX) is an intermediate in the formation of the carotenoids and sterols known to be present in the latex. Thus, rubber latex is an interesting biological system as it produces both high molecular weight all-*cis* rubber and low molecular weight all-*trans* terpenoids.

TABLE 2

*T*¹⁴C Ratios in Products Biosynthesized from [4R-4-T₁, 2-¹⁴C]- and [4S-4-T, 2-¹⁴C]-mevalonate by *Hevea brasiliensis* latex³⁰²

Precursor	Farnesol	Rubber
4R-Mevalonate (T/ ¹⁴ C ratio 7:17)	7:0	0:0
4S-Mevalonate (T/ ¹⁴ C ratio 4:54)	0:05	4:2

The stereochemistry of the formation of natural all-*cis* rubber and *trans-trans* FPP have been studied using stereospecifically-labeled MVA by Archer *et al.*¹⁶ and also Popják and Cornforth.³⁰² Latex from *H. brasiliensis* was used to synthesize rubber and farnesol from [4R-4-T, -2-¹⁴C]- and [4S-4-T, -2-¹⁴C]-mevalonate.‡ The results shown in Table 2 show that the T/¹⁴C ratio in rubber biosynthesized from the 4S-MVA was the same as in the starting MVA, whereas the rubber produced in the 4R-MVA experiment contained practically no tritium. This is just the opposite of what occurs during the biosynthesis of squalene. The farnesol produced simultaneously with the rubber showed the "squalene" pattern of labeling. These workers concluded that two distinct enzymes were responsible for the production of *trans-trans* FPP (XX) and *cis* rubber. Furthermore, it was predicted³⁰² that the stereochemistry of chain propagation in rubber biosynthesis proceeds as shown in Fig. 35 with the only difference from the *trans* pattern of biosynthesis being the conformation in which each successive isopentenylpyrophosphate molecule is bound to the enzyme.

During the course of latex flow, many of the enzymes involved in rubber synthesis are lost. Also lost are ribosomes and mitochondria that have been shown to present in latex.²⁶⁵ Immediately after the latex flow has stopped, rubber synthesis starts again in the vessel so that as much as 35 per cent of the original rubber concentration of the latex is restored within 48 hours. Since tapping can continue without reducing the yield of rubber over periods of many years, it is

† The isomerase is the only enzyme concerned with the formation of squalene from mevalonate known to be sensitive to iodoacetamide.

‡ See note, p, 187.

clear that the latex vessel must possess the power to regenerate its mitochondria, ribosomes, and the enzymes used in rubber synthesis. Apparently the nuclei of the multinucleate vessel do not flow out during a tapping but remain appressed to the vessel wall. According to Bonner,⁷⁸ "the genes which produce mRNA for synthesizing the rubber-making enzymes as well as the ribosome-making system must be depressed by the act of tapping since these products appear in abundance in the regenerating latex. As regeneration of the enzymes concerned

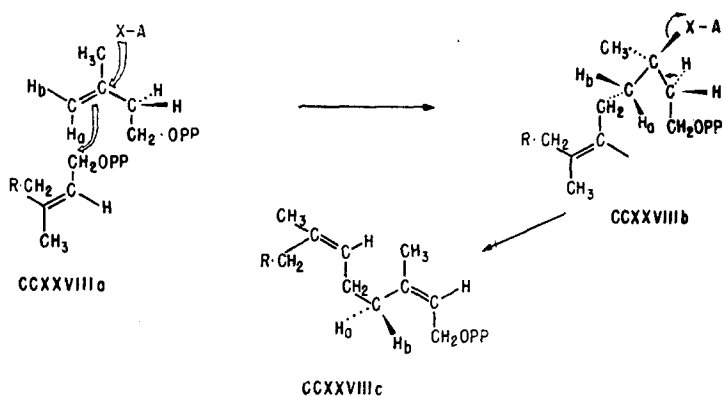

FIG. 35. Stereochemistry of rubber biosynthesis from IpPP.^{16, 302}

with rubber synthesis proceeds in the latex vessel and as the rubber concentration approaches the upper limit characteristics of the plant, the genes for making the rubber synthesizing enzymes must again be repressed and the enzymes for rubber synthesis must themselves be inhibited since all synthesis in the vessel ultimately ceases. The behavior of the cell contents of the latex vessel during the regeneration of the latex which follows a tapping cut would appear to provide an elegant example of derepression and repression both on the genetic and the enzyme level."

With the finding of polyprenols in leaves of the rubber plant,¹³⁹ it is interesting to speculate that since they are poly-*cis* alcohols with two or three internal isoprene residues in the *trans* configuration, perhaps the increment added to the growing chain in each case is a *cis* residue. If such did occur, then rubber may be derived from a family of poly-*cis* alcohols and perhaps rubber has a few *trans* units present. As mentioned, rubber, although called a hydrocarbon, in its natural state is probably the pyrophosphate of an isoprenoid alcohol (see Fig. 34).

III. METABOLIC RELATIONSHIP BETWEEN TERPENES AND ALKALOIDS

Thomas³⁸⁶ and Wenkert⁴¹⁵ recognized that the methylcyclopentane monoterpenes might serve as a precursor of certain indole alkaloids. This postulated link between alkaloids and terpenes has now been verified experimentally and

independently by Scott,^{184, 261} Arigoni^{165, 245} and Battersby,^{36, 37, 38, 39, 40} and their respective co-workers, and it appears that the rearranged skeleton is involved in the synthesis of indole alkaloids possessing the structures of the *Corynanthe*, *Aspidosperma*, and *Ipoga* types. Battersby⁴⁰ recently has shown that

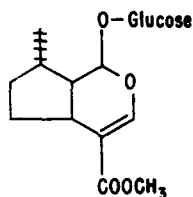

Loganin
CCXXX

the methylcyclopentane monoterpene glucoside loganin (CCXXX) can serve as a precursor to the indole alkaloids vindoline (CCXXXIV), catharanthine (CCXXXIII), and ajmalicine (CCXXXII), and he suggested that this compound (CCXXX) may be the key methylcyclopentane monoterpene precursor that connects these two classes of natural products. The reader interested in a discussion of biogenesis of the rearranged methylcyclopentane monoterpene skeletons is referred to the recent reviews by Taylor³⁸⁰ and the articles by Battersby, Scott, Arigoni and Thomas already mentioned. Coscia and Guarnaccia¹²² have recently shown that gentiopicroside (CCXXXI), a rearranged methylcyclopentane monoterpene which possesses the same carbon skeleton as the C₁₀ moieties of *Yohimbe*, *Rauwolfia*, *Cinchona*, and *Strychnos* indole alkaloids, can be derived from MVA in *Swertia caroliniensis*. Degradation of the gentiopicroside (CCXXXI) indicated that 20 per cent of the radioactivity was present in carbon atom 3 and the authors then rationalized its biosynthesis as shown.

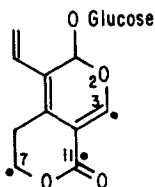

Gentiopicroside
CCXXXI

The experimental evidence relating terpenes and alkaloids is supported by feeding experiments with acetate (I), MVA (XI), and geraniol (XXII) labeled at various positions. *Vinca rosea* plants were used and the indole alkaloids were isolated and partly degraded to determine the location of the labeled carbon atoms. The results are in agreement with head-to-tail combination of the two C₅ units and it was logically deduced and subsequently confirmed that geraniol (XXII) is a precursor of the indole alkaloids of the *Corynanthe*, *Aspidosperma* and *Ipoga* groups. The proposed biogenetic pathway (Fig. 36) involves the

cyclization of geraniol (XXII) to provide a cyclopentanoid (CCXXXV) which undergoes ring cleavage to yield the unrearranged monoterpene with carbon skeleton CCXXXVI. Rearrangement of the monoterpene CCXXXVI occurs to give structures whose carbon skeletons are arranged as structures CCXXXVII or CCXXXVIII. These three basic monoterpene structures thus may be incorporated into the indole alkaloids as shown by the thickened bonds in: (a) ajmalicine (CCXXXII) which is related to terpene CCXXXVI (*Corynanthe*

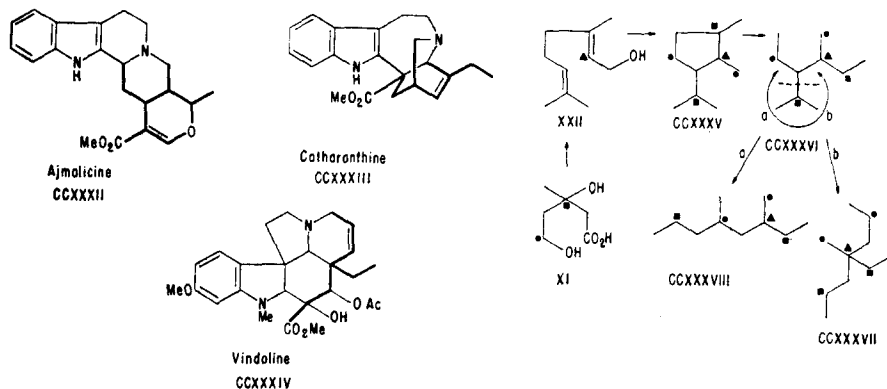

FIG. 36. Biogenesis of indole alkaloids from the rearranged methylcyclopentane monoterpene.³⁸⁰

family), (b) catharanthine (CCXXXIII) which is related to terpene CCXXXVIII (*Iboga* family), and (c) vindoline (CCXXXIV) which is related to terpene CCXXXVIII (*Aspidosperma* family).† Most of these results were obtained using carbon-14 or tritium labeled precursors but Scott's group¹⁸⁴ also used MVA-5-D₂-lactone and analyzed the deuterovindoline (CCXXXIVa) mass spectrometrically. The results are in agreement that a terpene such as CCXXXVII could be formed from the combination of two C₅ units to yield geraniol-1-D-5-D (XXIIa), which upon rearrangement would yield CCXXXVIIa. The resulting vindoline is labeled in the carbons shown. The most convincing evidence so far that a methylcyclopentane monoterpene is involved in indole alkaloid biosynthesis is provided by Battersby *et al.*⁴⁰ in experiments using O-methyl-³H loganin (CCXXX)‡§ as a precursor of *V. rosea* alkaloids. The labeled methyl ester group was removed and the remaining compounds were unlabeled. Their results showed that general methyl transfer was eliminated and were interpreted as supporting the specific incorporation of loganin⁴⁰ into the *Corynanthe*, *Aspidosperma*, and *Iboga* families of alkaloids. The next logical question to be raised was—does loganin occur naturally in *V. rosea* plants?

† There is no indication as to the state of oxidation of the monoterpene in these hypotheses.

‡ Loganin is found in *Strychnos nux-vomica* (K. Sheth, E. Ramstad, and J. Wolinsky, *Tetrahedron Letters*, 12, 394 (1961)).

§ Other methylcyclopentane monoterpene structures tested as possible precursors of the indole alkaloids were monotropeine methyl ester, verbenalin, dihydroverbenalin, and genepin. All four substances were shown not to be incorporated into the indole alkaloids produced by *V. rosea*.⁴⁰

Battersby *et al.* tested this using geraniol-1- ^3H (XXII) as a precursor and by radiochemical dilution using unlabeled loganin and concluded that 0.02 per cent incorporation of the precursor was recovered in the loganin (CCXXX). Although more definitive experiments are needed, the present data support the role of the methylcyclopentane monoterpene as being the link between terpenes and alkaloids

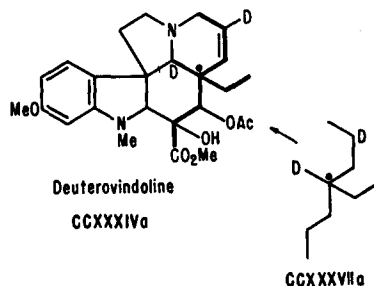

and, more specifically, it now appears that loganin (CCXXX) may be the key compound involved in their linkage.† The possibility of other methylcyclopentane monoterpene intermediates (i.e., verbenalin (LXXXIII), gentiopicroside (CCXXXI), etc.) serving in this kind of an intermediate cannot be ruled out at this time.

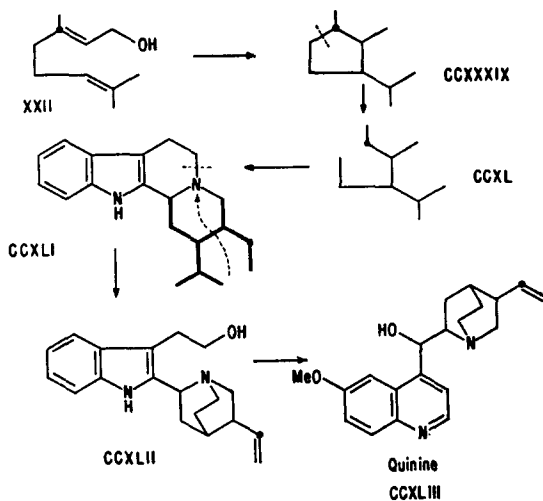

FIG. 37. Biogenesis of quinine.²⁴⁰

It should also be pointed out that quinine (CCXLIII), which can be formed from tryptophan,²²⁷ can also incorporate geraniol^{137, 240} (XXII). A methylcyclopentane monoterpene intermediate (CCXXXIX) was suggested based on the structural resemblances as shown in Fig. 37.

Thus, in two families that produce indole alkaloids, the Rubiaceae (*Cinchona*

† It is of interest to note that Dr. Carmine J. Coscia has found loganic acid and loganin in small amounts in *Swertia carolinensis*, the plant that produces gentiopicroside.^{121, 122} Geranylpyrophosphate-1- ^{14}C can serve as a precursor of loganic acid.

and *Corynanthe* species) and the Apocynaceae (*Aspidosperma*, *iboga* (*Tabernanthe iboga*) and *Vinca*), the metabolic relationship between terpenes and alkaloids appears to proceed through a methylcyclopentane monoterpene intermediate.

IV. REGULATION OF TERPENOID METABOLISM

The regulation of terpenoid biosynthesis has been studied mainly at three levels of cellular organization. The first of these involves the common biosynthetic pathway used to form geranylpyrophosphate (XIX) already described; the second is based on studies with chloroplasts, microsomes, and mitochondria; and the third is based on morphological findings. Goodwin¹⁶⁹ has recently

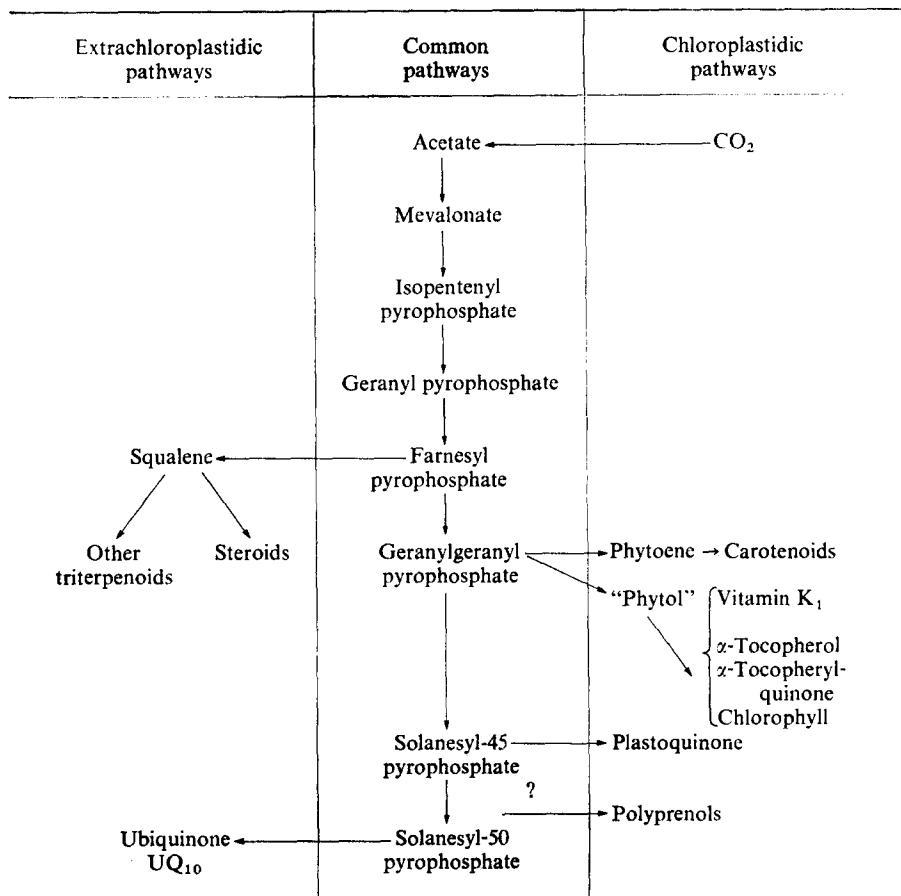

FIG. 38. Proposed scheme segregation of enzymes concerned with terpenoid biosynthesis in developing seedlings.¹⁶⁹

reviewed the first and second points of this subject as it applies to higher plants and suggested the following scheme (Fig. 38). He considers that the main aspects of the regulatory mechanism in higher plants is: (a) the segregation of enzymes (the enzymes essential for the basic reactions being present both inside and outside the chloroplasts, whereas those specific to the production of "chloroplast terpenoids" are present only in that organelle and those essential to triterpenes are mostly outside), and (b) the relative impermeability (either way) of the chloroplast membrane to mevalonate. Light plays an important role in terpenoid biosynthesis, as indicated by the fact that when etiolated seedlings or *Euglena* are illuminated the primary terpene precursors are diverted from sterol (and other triterpenoid) synthesis and utilized for the synthesis of the terpenoids which accumulate in the developing chloroplasts. Goodwin rationalizes this compartmentalization in the following statements:¹⁶⁹ "During germination extraplastidic synthesis of sterols required for membrane and lamellae formation occurs from endogenous food supplies and the mevalonate involved cannot penetrate the immature plastid to form unnecessary pigments. As soon as the seedling comes out of the ground and is illuminated, the sterols are transferred to the plastids which rapidly become functional by fixing CO₂ into mevalonate which is used for the synthesis of chloroplast terpenes; these are quickly incorporated together with the sterols, transferred from the 'microsomes' into lamellae and grana; because of the impermeability of the limiting membrane of the chloroplast, the mevalonic acid cannot get out to synthesize sterols and other triterpenes which are not immediately required. Later, the sucrose, formed in the chloroplast, can move out and provide the extrachloroplastidic mevalonic acid required to produce the sterols necessary for further growth of the plant."

It appears evident to this author that considerable confusion exists concerning the metabolic control and disposition of terpenoids in plants. Goodwin²⁶⁹ and Nicholas^{278, 284} find most of the squalene (CLXV) in the extraplastidic fraction of a wide variety of plants studied. There is also a relatively large amount of sterol as a sterol ester in chloroplasts.²⁸⁷ Goodwin suggested that the sterol esters might serve as "transfer sterol" which could be moved from the microsomes to the chloroplasts. Beeler *et al.*⁴³ found that squalene could be formed from MVA in chloroplasts, thus indicating that the enzymes required must be present in these organelles. Further evidence for the complexity of the problem is provided by the finding that isolated chloroplasts synthesize fatty acids from acetate-2-¹⁴C, but not non-saponifiable material (i.e., sterols).³⁷³ The impermeability of the chloroplast cannot be invoked in this case.

Other areas that may be worth exploring in more detail are environmental effects,^{88, 190} and the specialized cells, i.e., oil glands,^{246, 316} and the relationship to plant growth and development.^{22, 246} For example, Burbott and Loomis⁸⁸ analyzed the monoterpenes of *Mentha piperita* (peppermint) and found that they were strongly influenced by environmental conditions; but concluded that photoperiod had no direct influence on monoterpene metabolism. They suggested that the oxidation-reduction level of the monoterpenes reflects the oxidation-reduction state of the respiratory coenzymes of the terpene-producing cells and

that this, in turn, was dependent upon the concentrations of respiratory substrate in the cells. This suggestion was based on the likelihood that warm nights cause depletion of respiratory substrates, resulting in oxidizing conditions, while cool nights preserve high levels of substrates, thus maintaining reducing conditions. The specialized cells, i.e. oil glands, may play a very important role in control of terpene synthesis; however, until it is known if the terpenes are synthesized *in situ* or are translocated from some other part of the plant, we are forced to rely largely upon circumstantial evidence. Loomis⁸⁸ points out that there is considerable evidence which indicates that the site of monoterpene formation and degradation in plants is isolated, both from the air as well as from the rest of the plant. Morphological studies on peppermint oil glands with the light microscope²¹⁰ and with the electron microscope¹⁰ show that access to the gland is through a heavy cuticle or through a single-celled stem, presumably through the protoplast of the stem cell. Recently, Amelunxen¹¹ has found bundles of fibrous material which appear to be precursors of the essential oil of peppermint. Furthermore, he noted that these fibrous bundles were found throughout the leaf, not only in the oil glands. Microscopic examination of leaf cross-sections of the catnip plant prepared from leaves at three different stages of development show (Fig. 39) several types of glandular structures.³¹⁶ The glands occur on both sides of the leaf. These glands are multicellular, resting between hairs arising from the cuticle or epidermis. They appear to originate from a single cell and change in shape with development. In the early stage (Fig. 39A) no stalk is visible; in the intermediate stage (Fig. 39B) formation of a stalk with a globular head is seen. In the late stage (Fig. 39C) the globular structure is expanded and the stalk is enlarged. These stages of development are similar to those found in the glandular trichomes of *Hemizonia minthornii* reported by Carlquist.⁹⁷ These glands have a fragile membrane, since the lightest brushing with the finger-tip produces a pronounced odor of catnip oil. This fragility serves to explain why cats roll over and over in catnip plants and increase their body activity as the vapor around them becomes more saturated with catnip oil.

Differentiation in the manner that cells incorporate MVA-2-¹⁴C into terpenoids has been observed.¹⁷⁵ For example, in the wild cucumber, MVA metabolism in the endosperm nucellus appears to be directed to diterpenoid biosynthesis, while that of the embryo of the same seed may be directed to the synthesis of triterpenoids.

Another point to be considered is that primary terpene products, once formed, leak into compartments where they are secondarily transformed; for example, the terpenes of pines are made in glandular cells and secreted into resin ducts where secondary transformations can occur.⁷³

Tracer studies with a variety of plant species have shown that the time and method of administration have to be carefully selected before one can hope to demonstrate the biosynthesis of any monoterpene. Whereas the levels of incorporation into peppermint monoterpenes are quite low (0.0–0.1 per cent), those of the methyl-cyclopentane monoterpenoids, skytanthine (LXXX) and verbenalin (LXXXIII), are relatively high (0.5–1.5 per cent of the MVA-2-¹⁴C

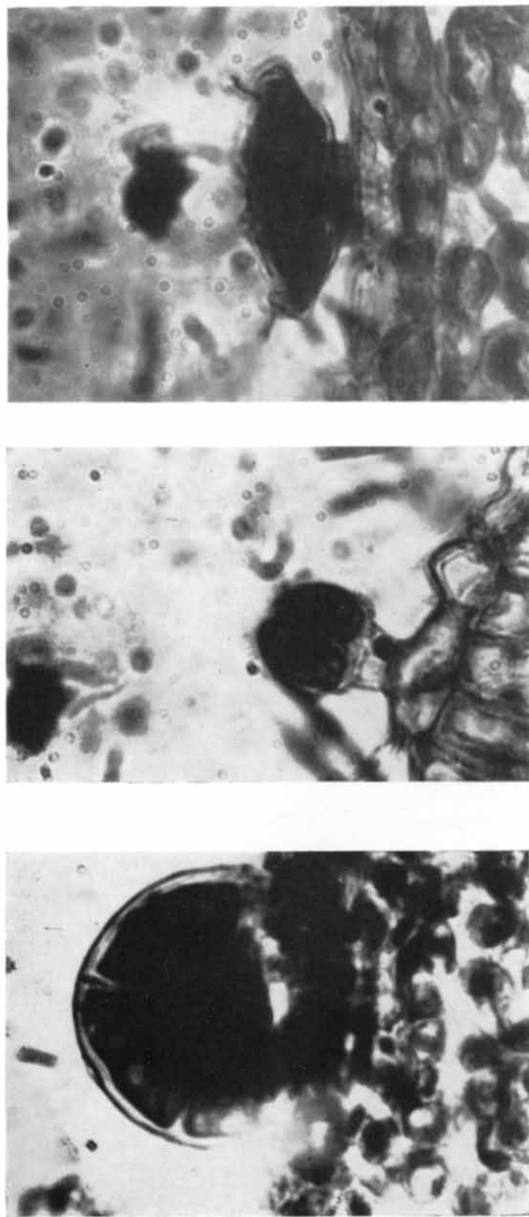

FIG. 39. *Nepeta cataria* L. transverse (cross) sections of leaf tissue.³¹⁶ A. Early stage $\times 1125$. B. Intermediate stage $\times 562.5$. C. Later stage $\times 562.5$.

administered). $^{14}\text{CO}_2$ has usually been the best substrate, and sometimes acetate serves as a better precursor than MVA, which is usually rather poor (see comments on page 169). The recent report of Battu and Youngken⁴² indicate MVA and acetate were degraded to CO_2 and then reincorporated into monoterpenes of peppermint via CO_2 fixation; however, no degradation studies were conducted.† In contrast to these results is the conclusion obtained with the diterpene marrubin (CLVIII), where the evidence suggested TCA cycle acids acetate and pyruvate were degraded to acetate prior to incorporation, whereas MVA was not.⁷⁸

The variation in enzymatic mechanism due to age must be considered, although significant differences in the amount of incorporation of radioactivity from melvionate into skyanthine²² and verbenalin²⁰⁹ when plants of different ages were used was not observed. Several possible types of enzymatic control as well as control by substrate pool size that were mentioned (see page 171) can be envisioned.²²

Lastly, the genetic control over terpenoid metabolism must be considered. There have been several chemotaxonomic or biochemical systematic studies, particularly of the monoterpenes, conducted. As more detailed information on biosynthesis and catabolism of the various classes of terpenoids becomes available, then a clearer understanding of the genetic control and its evolutionary significance will be forthcoming. Plant breeding experiments with the species *Mentha* have yielded some useful information on the genetic control of monoterpene metabolism in this species.^{8, 274, 275} According to Murray,^{274, 275} a single pair of genes controls, either directly or indirectly, the major distribution of monoterpenoids in mint oils. The groupings for terpenoid production are: (a) acyclic monoterpenes as in *Mentha citrata* (bergamot mint), (b) 2-oxygenated cyclic monoterpenes as in *M. spicata* (spearmint), and (c) 3-oxygenated cyclic monoterpenes as in *M. piperita* (peppermint). The action of the dominant gene apparently is upon a cyclic intermediate to convert it to a spearmint [2-oxygenated series as represented by carvone (LXXIX)] type oil, while in the presence of only the recessive gene the cyclic intermediate is converted to a peppermint [3-oxygenated series as represented by piperitenone (LXVII)].^{271, 320} Loomis²⁴⁶ suggests that these data indicate that the gene which differentiates between the carvone series and the pulegone series may be the one that determines the position of the double bond. He proposes that α -terpineol (XLIX) or the corresponding carbonium ion (Fig. 40), or an equivalent enzyme-bound form, is an intermediate. The formation of the double bond by dehydration produces either limonene (L) or terpinolene (CCXLV), depending on which hydrogen atom is lost. Further oxidation to yield the ketones and subsequent dehydrogenation would be expected to occur by action of rather non-specific enzymes. The oxygenase is specific in the sense that oxygen is added in the α -position to the double bonds. Murray²⁷⁴ also showed that the reduction of menthone (LXX) to menthol (LXXIII) is predominantly controlled by a single gene, with the allele for menthol production being dominant. Thus, it seems likely that a dehydro-

† The two-hour boiling of mevalonic lactone-2- ^{14}C in alkali and the long exposure of the substrates to the plant roots may have facilitated the degradation.

genase is under the control of this gene—in fact, it could be a non-specific alcohol dehydrogenase. By analogy, crystalline horse liver alcohol dehydrogenase can oxidize geraniol¹⁸⁷ and farnesol⁴⁰⁷ to their corresponding aldehydes, and carrot slices catalyze the same reaction.⁴⁰⁰ It may be that the recent finding that nepetalactone (LXXXIV) is predominantly produced by *Nepeta cataria* (catnip), whereas its stereoisomer, epinepatalactone (CCXLVII), is the primary product of *N. mussini* (catnip), while *N. citriodora* produces primarily acyclic monoterpenoids, provides another example of the genetic control of terpenoid synthesis.^{314, 315} In this example there is a pronounced difference from the

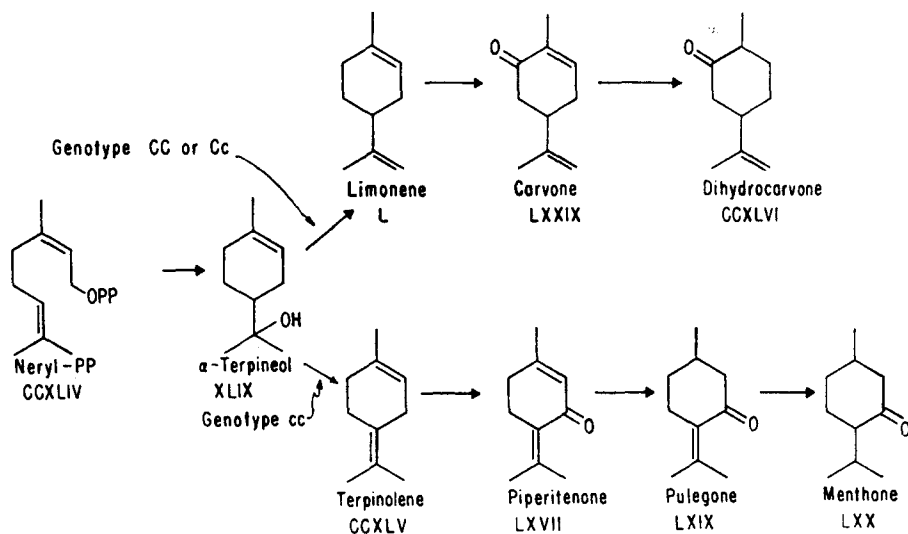
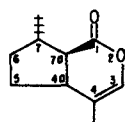
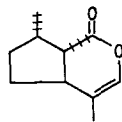

FIG. 40. Postulated pathways of monoterpenoid metabolism in mint plants based on genetic evidence.^{246, 274, 275}

mint monoterpenoids since these molecules (LXXXIV and CCXLVII) are the same except for the stereochemistry around one of the asymmetric centers (carbon-7a). It might be that one gene controls the enzyme that catalyzes the closing of the six membered ring (see biogenesis scheme, Fig. 16, and also page



Nepetalactone
LXXXIV



Epinepatalactone
CCXLVII

177); if so, this is a very subtle control and the *raison d'être* is not apparent. For more information on biochemical systematics the reader is referred to the books by Alston and Turner⁸ and Swain.³⁷⁶

V. CATABOLISM

The degradation of terpenoids must be considered by both the higher plant or micro-organism in which they are produced and by animals, including man, in which they are used for medicinal or culinary purposes. During the last few years, studies on the microbial degradation of terpenoids have appeared.

A. *Catabolism by animals*1. *Open-chain terpenoids*

Lipid-soluble foreign compounds, such as many of the terpenoids, which find their way into the body would be doomed to remain there for days, weeks, and, in some cases, even for months, were the organism not capable of converting them into more polar, less lipid-soluble substances.^{80, 321} Such a conversion prevents them from re-entering the blood path by way of diffusion through the tubular cell membranes of the kidney once they have been filtered through the glomerulus into the tubular lumen.^{321, 352} The speed with which the compound (in this case, the terpenoid) penetrates the barrier is dependent upon the diffusion gradient and the relationship of its solubility in lipids to that in water. Small amounts of terpenes or terpenoids are continually being ingested, absorbed and metabolized by man and other animals, although most herbivorous animals consume large quantities of plant material and, consequently, must metabolize considerable quantities of terpenoids. The terpenoids to be discussed are found in essential oils, in extracts of citrus fruits, and in a variety of plants used for medicinal or culinary purposes. Our state of knowledge concerning the metabolism of these compounds in animals is primitive, and it logically follows that much research must be done before this area gains the respectability that biosynthesis research now holds. Many of the factors considered in drug metabolism^{80, 321, 352} such as protein binding, dissolving of the terpenoid in fat, localization in tissues, absorption from the gastro-intestinal tract, and route of administration should be considered. Williams⁴²⁰ has reviewed the metabolism of terpenoids through 1958.

1-Borneol (LVI) has been found in the contents of the perfume gland of the beaver; it is assumed that it came from plant material eaten.²³⁸ Citronellal (XXXII) is one of the main constituents of yacarovol, the gland secretions of the alligator.³⁶⁰ It is assumed that these compounds accumulate as the result of translocation, and perhaps some type of an "active up-take" of 1-borneol or citronellal occurs.

The notable early contributions in the metabolism of terpenoids by animals were by Hildebrandt^{204, 205, 206} and by Kühn and co-workers^{229, 230, 231} who studied the fate of a number of monoterpenoids in domestic animals. The production of Hildebrandt's acid (XXXV) from methylgeraniolene (XXXIV), which does not occur naturally, was described⁶⁴ earlier (Fig. 7, page 163). Dihydromyrcene (see structure XXVIII for myrcene), geraniol (XXII), citral (XXIV), and

geranoic acid undergo ω -oxidation to give Hildebrandt's acid, which is isolated from the urine of dogs and rabbits fed these monoterpenoids,^{204, 229} whereas cyclocitral and cyclogeraniol are excreted as the glucuronides.^{206, 229} Citral has been reported to have tumor-inhibiting properties,⁷⁵ but it can cause vascular endothelia if ingested in large amounts.¹⁵² In vascular endothelia, it is thought to act as a retinene competitor. Citral also yielded 2,3-dihydro-Hildebrandt's acid. Citronellal (XXXII), the chief constituent of citronella oil, is oxidized by the rabbit to give a cyclic compound [*p*-menthane-3,8-diol (CCXLIV)] which is excreted in the urine as the glucuronide (CCXLV); however, it was

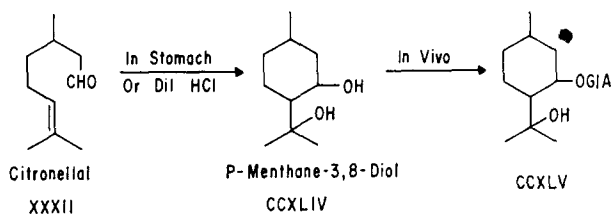

shown that cyclization was probably not a true biological process, but a chemical one which took place under the influence of gastric hydrochloric acid. It is interesting that cyclization occurred, since to form 2,3-dihydro-Hildebrandt's acid from citronellal would require only terminal methyl group oxidation. Citronellol (XXVII) does not undergo cyclization in the rabbit and the main excretory products are optically active forms of 7-hydroxymethyl-3-methylocta-6-enoic acid and 7-carboxy-3-methylocta-6-enoic acid.¹⁵²

A hereditary recessive disease affecting primarily nervous system function, known as Refsum's disease,³¹⁸ is associated with an accumulation of phytanic acid [3,7,11,15-tetramethyl hexadecan-1-oic acid (CCXLVI)] in serum and tissues²²⁴ of the individual; consequently, the metabolism of phytol (CXLII), the side-chain of chlorophyll, and its saturated derivative, phytanic acid, is receiving increased attention. Presumably, the metabolic error is a relative inability to break down the branched chain structure of phytic acid, although this has not been rigorously established. The feeding of phytol in large doses (2-5 per cent by weight in the diet) leads to the accumulation of phytanic acid in the human, mouse, rat, rabbit, and chinchilla.^{192, 225, 228, 369, 370} The accumulated phytanic acid may reach levels of as high as 60 per cent of the total fatty acids in the liver and 40 per cent of the total in the serum. After the phytol is removed from the diet, the phytanic acid level returns to normal, which indicates the ability of the normal animal to readily metabolize this compound. Studies on phytol-U-¹⁴C²⁷² showed that 30 per cent of the dose was converted to CO₂ in 18 hours after oral administration, compared with 20 per cent conversion to CO₂ in 4 hours after intravenous administration. This is comparable to the rate at which palmitic acid is metabolized to CO₂. The phytanic acid-¹⁴C was distributed widely throughout the body with the highest concentration being found in the liver and adipose tissue. Apparently no endogenous biosynthesis of phytol or phytanic acid occurs as indicated by the lack of incorporation of

radioactivity into these compounds when the subject was fed MVA-2-¹⁴C or acetate-1-¹⁴C; hence, the source is dietary. Phytol can be metabolized to phytanic acid through the intermediates 2-phytenic acid or 2,3-dihydrophytol.

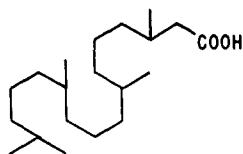

Phytanic Acid
CCXLVI

The pathway for the conversion of phytanic acid to CO₂ remains to be elucidated. Ruminants have readily measurable quantities of phytanic acid in their blood (>1 per cent of the total fatty acids), but monogastric animals normally have only trace amounts.²⁵¹ Small amounts of phytanic acid are present in butter fat.¹⁹¹ It has been suggested¹⁴⁹ that the pathway for the degradation of phytanic

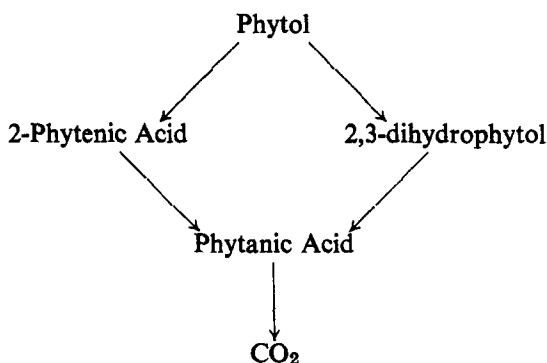

acid proceeds in another manner, rather than either the classical β -oxidation or ω -oxidation. Possible alternative metabolic pathways would be the oxidation of the terminal carbons as in the formation of Hildebrandt's acid or in the bacterial oxidation of acyclic monoterpenoids to be described in the following section.

DmaPP (XVIII), GPP (XIX), and FPP (XX), well-known metabolites in squalene biosynthesis from MVA, are metabolized by the liver by an alternative pathway to their corresponding acids.¹¹⁰ This transformation proceeds by: (a) irreversible dephosphorylation into the free terpenoid by a microsomal phosphatase, followed by (b) irreversibly dehydrogenation to the acids by horse liver alcohol dehydrogenase (LADH) and aldehyde dehydrogenase present in a soluble protein fraction of liver homogenate.¹¹⁰ It was of interest to find that the terpenols are more specific substrates for LADH than is ethanol, but they cannot act as substrates for yeast alcohol dehydrogenase. It is interesting to speculate on the effect of LADH on farnesol considered as a normal physiological

substrate for this enzyme⁴⁰⁷ in humans. It is known that the human liver can dehydrogenate a maximum of 250 g of ethanol each day;³⁸⁴ correspondingly, it may be calculated that about 15 g of farnesol could be oxidized to farnesal per day. Farnesol in the liver arises primarily as a by-product of cholesterol biosynthesis, by hydrolysis of farnesylpyrophosphate, but it is not known what quantities of this intermediate are diverted to this alternative pathway. It is likely that most of the farnesol in mammals is produced by that animal; however, some is ingested. The daily production of cholesterol in the human liver is about 4 millimoles, requiring the previous conversion of 8 millimoles of farnesylpyrophosphate into squalene. If it is assumed that one-half of the farnesylpyrophosphate synthesized acts as sterol precursor, and the other half is metabolized via free farnesol, about 0.9 g of farnesol could be available for dehydrogenation, well within the calculated capacity of the liver. Obviously, these calculations are somewhat speculative, since the horse liver enzyme may be different from the human; nevertheless, the order of magnitude of the calculated values appears to be correct.

2. Cyclic terpenoids

Human urine contains uroterpenol (CCXLVII), a monoterpene structurally derived from limonene (L), which is especially plentiful in citrus fruits.⁴²²

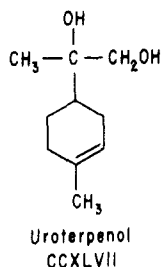

Uroterpenol is excreted as a conjugate with glucuronic acid and it was observed that the concentration increased following the ingestion of orange juice or an aqueous homogenate of whole lemon known to contain limonene. When orange juice containing no limonene was ingested, no increase in uroterpenol was observed. The possibility exists that a sesquiterpene urinary metabolite, called X₆,²⁰⁷ which has been shown to be an α - β -unsaturated ketone, is also of terpenoid origin.

In rabbits, *p*-methene¹⁸⁶ forms a conjugated glucuronide of unknown constitution; however, there was an indication that oxidation occurred at carbons 2 and 4. Sheep convert α -phellandrene (CCXLVIII) to phellandric acid (CCL), carvotanacetone (CCLIII), *p*-cymene (CCLIV), and possibly phellandral (CCXLIX).¹⁸⁸ Phellandric acid (CCL) is excreted partly as the glycine conjugate, phellandric acid.⁴²⁷

Carbone (LXXIX) is excreted as a glucuronide by the rabbit²⁰⁵ in which one ethylenic bond becomes saturated and the keto group reduced.¹⁵² d-Pulegone

(LXIX) is converted to d-menthol (LXXIII) and 1-pulegol in the rabbit, both being excreted as the glucuronides.²⁰⁵ Piperitone (LXVIII), used for the minty flavor in dentifrices, is converted by sheep to carvotanacetone (CCLIII), thymol, and possibly diosphenol (both contain the 1:2 double bond), all steam distillable products recovered from urine.¹⁹⁸ 1-Menthone (LXX) is reduced by the rabbit to give d-neo menthol (LXXII), but no 1-menthol (LXXIII) was detected; d-iso-menthone (LXXV) is reduced and the reduction products are excreted as their glucuronides.⁴¹⁸

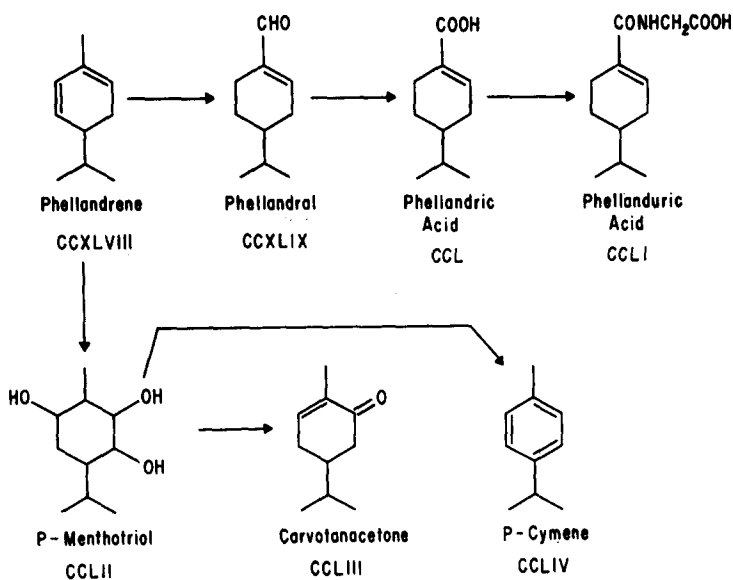

Generally the monocyclic terpene alcohols conjugate with glucuronic acid in the animal body, with the uronic acid residue becoming attached to the existing —OH group,⁴²⁰ i.e. 1-menthol (LXXIII) or mint camphor, which is widely used as an anaesthetic and antiseptic, is excreted by the rabbit as 1-menthyl- β -D-glucuronide, originally important as a source compound for isolating glucuronic acid. Only about one-half of the administered menthol is recovered as the glucuronide, the fate of the other one-half being unknown.⁴¹⁹

Still less is known about the catabolism of terpenoids with more than one ring. Thujyl alcohol (CCLV), which occurs in the oil of worm-wood, is converted to a mixture of its glucuronide (CCLVI) and *p*-menthane-2,4-diol (CCLVII),⁴²⁰ and thujone [(LIX); the corresponding ketone] gives similar products. On the other hand, if an unsaturated linkage is present in thujyl alcohol (CCLV) at the 1,2-position (i.e., sabinol), then the bicyclic ring structure is not broken.

Little information is available on the metabolism of α - and β -pinene, although an early report¹⁸⁶ indicates they are excreted as glucuronides. α -Pinene causes sheep to develop albuminuria, and has a toxic action on the liver and kidneys.¹⁹⁸ d-Borneol (LVI) is excreted by man as bornyl-glucuronide, and the rate is

about 80 per cent of a 2 g dose in 2 hours.^{310, 420} Camphane (see CXIV), the hydrocarbon related to borneol, is apparently oxidized to a mixture of d- and l-borneols, and subsequently excreted as their glucuronides.

Considerable interest that dates back almost a century has been shown in the metabolism of camphor (CCLVIII), probably due to its use as a temporary cardiac stimulant. In 1879, Schmiederberg and Meyer³⁵⁴ isolated three camphor

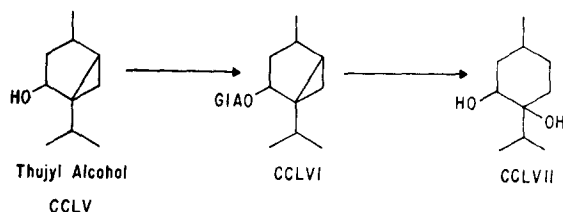

metabolites from dog urine. About fifty years later, Asahira and Ishidate²¹ identified these main dog metabolites as 3- and 5-hydroxy camphor (CCLIV, CCLV) with smaller amounts of *cis*- and *trans*-*n*-hydroxy camphor (CCLVI) and *trans*-*n*-apo-camphor-7-carboxylic acid (CCLVII). Compounds possessing the fenchane skeleton (CCLVIII) and the santene skeleton (CCLIX) appear to be stable *in vivo* also, much as does the camphor series, i.e. they are oxidized without breaking the ring structures and excreted as the glucuronides.⁴²⁰

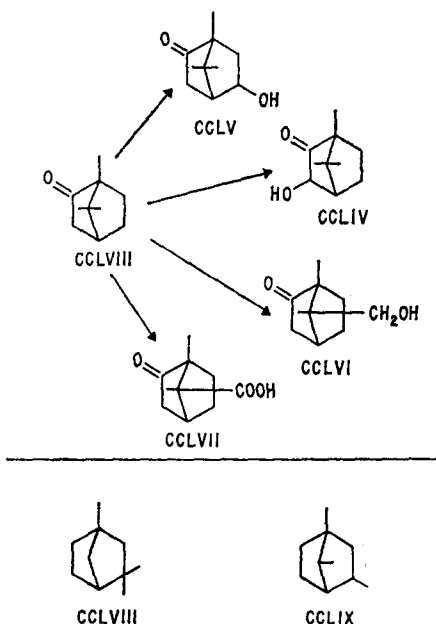

The metabolism of the feline attractant, nepetalactone (LXXXIV), has been studied by administering large doses (50 mg) to a cat by force-feeding the compound contained in a capsule.³⁰⁹ The cat showed no physiological response nor

any signs of toxicity. Nepetalactone-¹⁴C was administered to a cat in a metabolism chamber, and the results showed that over 85 per cent of the radioactivity was recovered in the urine. Analysis of the urinary metabolites have indicated that the lactone ring was opened and that the main product excreted was nepetalinic acid (CCLXI) (Fig. 41). Nepetalic acid (CCLX) is probably an intermediate in the reaction. Other radioactive compounds were recovered, but were not identified.

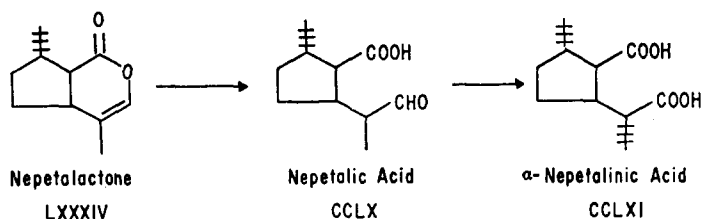
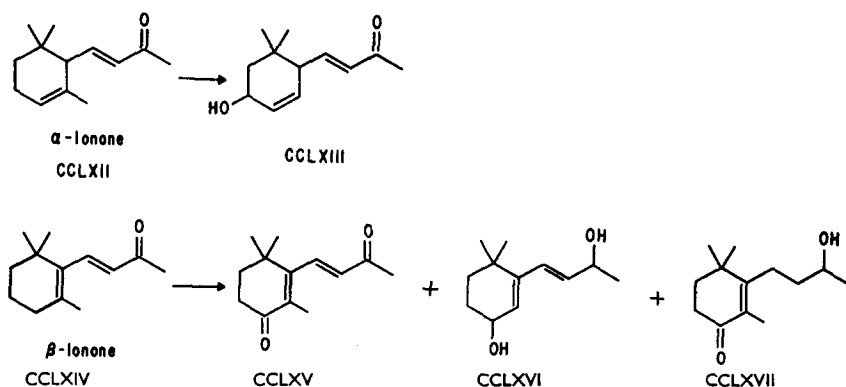

FIG. 41. Metabolism of nepetalactone by the cat.

The α - and β -ionones (CCLXII and CCLXIV) are ketones that have the odor of violets and are used in perfumery. The β -ionone ring system is similar to that found in β -carotene and Vitamin A. Ionone derivatives have been reported to be present in the "keto-steroid" fraction of horse and cattle urine. α -Ionone (CCLXII) is hydroxylated in the ring at the α -carbon atom to the double bond to yield 5-hydroxy- α -ionone (CCLXIII)³⁰⁸ by the dog. β -Ionone (CCLXIV) is converted to β -keto- β -ionone (CCLXV), 4-hydroxy- β -ionol (CCLXVI), and 4-keto- β -ionol (CCLXVII) by the rabbit.³⁰⁷ In addition, the recovery of administered β -ionone has been reported.⁵⁹ It may be concluded that oxidation



of the ionones is restricted to the carbon atom α to the ring double bond. The isolation of 5-hydroxy-*cis*-tetrahydro-ionone and 5-keto-*cis*-tetrahydro-ionol from the urine of cattle and pregnant mares has been reported, and it is thought that these compounds are derived from the forages consumed by the ruminants; this argument was strengthened by the lack of such products being detected in the dog urine.³⁰⁸

It is beyond the scope of this review to describe the extensive studies on the animal metabolism of the carotenes (pro-vitamins A), Vitamins E and K, Coenzymes Q, and steroids, of which each would require a separate article for adequate treatment. Nicholas²⁸⁴ covers some of the more recent information on the isoprenoid vitamins and isoprenoid quinones. In addition, the reader is referred to the reviews cited in the introduction as well as standard books on the subjects. It is clear that research on the metabolism of lower molecular weight terpenoids by animals has received only cursory treatment, and that was conducted mostly at a time prior to the widespread use of radioisotopes; thus, the future in this aspect of terpenoid metabolism looks especially rewarding.

B. Catabolism by micro-organisms

Gunsalus and co-workers^{107, 113, 114, 115, 194, 390, 391} have studied extensively the oxidation of the bicyclic monoterpene D-(+)-camphor (CCLVIII). Two types of ring cleavage mechanisms were found to occur. This group has made outstanding progress in characterizing many of the reactions at the enzyme level. The known intermediates in the degradation of camphor by a soil diptheroid, strain T₁, are shown in Fig. 42, where both alicyclic rings are cleaved by lactonization reactions.^{107, 113, 115} The pathway was deduced from the identifica-

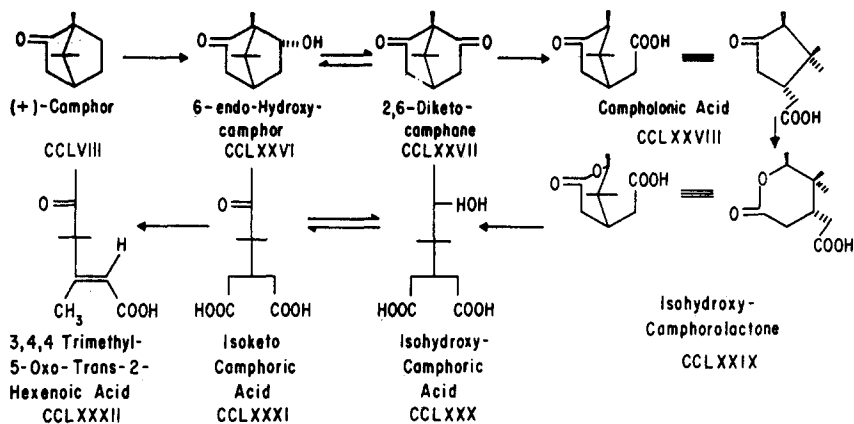

FIG. 42. Oxidation of (+)-camphor by a soil diptheroid, strain T₁.¹¹³

tion of the intermediates and their use in enzyme studies. The steps involved in the cleavage of the first ring are: (a) direct 6-endo-hydroxylation of camphor to (CCLXXVI), (b) the NAD⁺ mediated dehydrogenation of (CCLXXVI) by an inducible dehydrogenase to form 2,6-diketocamphane (CCLXXVII), (c) hydrolysis to (-)-campholonic acid (CCLXXVIII) by a stereospecific β -diketone hydrolase. Cleavage of the other ring occurs by a keto-lactonase system similar to the pathway utilized by *Pseudomonas putida*¹¹³ to give the dicarboxylic acid (CCLXXX) which can be reduced to the hydroxy acid (CCLXXXII) by a specific inducible NADH-coupled alcohol dehydrogenase.¹⁰⁷ The lactonization reac-

tion has been studied in great detail by the same group;^{390, 391} the ketolactonizing enzyme system has been purified ten-fold from *P. putida* and contains flavin mononucleotide and flavin adenine dinucleotide. Its electron transport system shows a unitary stoichiometry of reactants and products.³⁹¹

Another camphor (CCLVIII) oxidation by a *Pseudomonad* strain C₅, isolated from soil by the enrichment culture technique, is capable of metabolizing camphor, leading to the formation of a new series of intermediates with the reaction sequence proceeding as shown in Fig. 43.^{114, 194} The reaction sequence for *P. putida*, strain C₁ is: CCLVIII → CCLXVIII → CCLXIX → CCLXXIII → CCLXXIV → CCLXXV with CCLXX as a side product, and the reaction sequence for strain C₅ is: CCLVIII → CCLXXI → CCLXXII → CCLXXIII → CCLXXIV → CCLXXV.

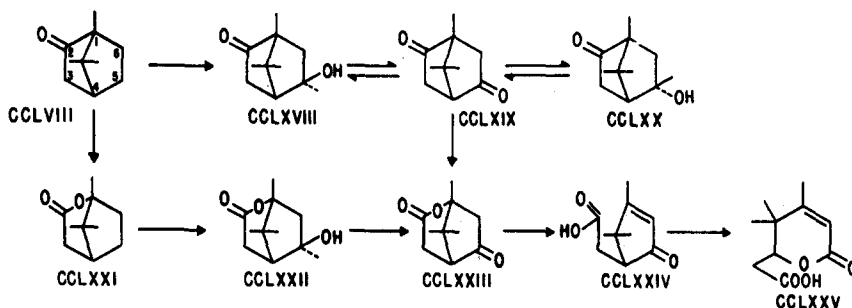

FIG. 43. The lactonization reaction in the metabolism of camphor by *Pseudomonads*.¹⁹⁴

The Battacharyya group^{58, 135} has been quite active in studying the microbiological transformation of terpenes. The degradation of limonene (L) by a soil *Pseudomonad* occurs by oxidation at different positions on the monoterpene molecule (carbons 6, 7, 4, and on the ring and exocyclic double bonds) shown in Fig. 44. A series of degradation products are produced,⁵⁸ most retaining the ring skeleton, but cleavage of the ring double bond to produce a dicarboxylic

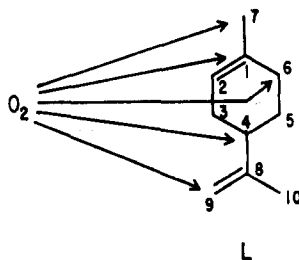
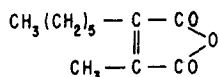

FIG. 44. Mode of oxygen attack on limonene by a soil *Pseudomonad*.¹³⁵

acid was also shown to occur. *Aspergillus niger* accumulated 2-nonenone, 2,3-dicarboxylic acid anhydride (CCLXXXIX) when grown in the presence of the sesquiterpenoid hydrocarbons: caryophellene, longifolene, δ -cadienene, β -

santolene, and camphene. Apparently the anhydride (CCLXXXIX) originates from glucose and not from the terpenoids as was originally thought.



2-Nonene, 2, 3-Dicarboxylic Acid Anhydride

CCLXXXIX

The complete degradation of geraniol (XXII) and farnesol (CXVIII) to CO_2 by *Pseudomonas citronellolis*, a bacterium isolated from the soil under pine trees, has been reported.³⁵⁶ Citronellol (XXVII) is the carbon source used for cultivating the organism. The enzyme geranylcarboxylase³⁵⁷ (purified 200-fold) initiates the degradation of the terpenols (XXII, CXVIII) (Fig. 45); the enzyme requires Mg^{++} , ATP, and biotin. Dimethylacrylyl-CoA (CCLXXXVIII), geranyl-CoA (CCLXXXIV), and farnesyl-CoA (CCLXXXIV) are carboxylated at the branched methyl group in the β -position to the carboxyl group and the enzyme is specific for the *cis* isomer (CCLXXXV). The fixed CO_2 is then eliminated, after the addition of water to form CCLXXXVI, with the methyl group as free acetic acid (I), then carbon atoms 1 and 2 are converted to acetyl-CoA (II) via β -oxidation. The cyclic process shown in Fig. 45 leads finally to dimethylacrylic acid, which subsequently is degraded through the reaction sequence employed for leucine degradation.

C. Catabolism by the organisms that produce them

There is an increasing body of evidence that indicates that "secondary metabolites" such as terpenoids and alkaloids are not merely accumulated in the organism, but that they are metabolically active. In the case of the terpenoids, particularly the monoterpenoids, and less so the sesquiterpenoids, some loss due to vaporization through the cell wall occurs—a situation not encountered with the alkaloids and higher terpenoids except for the relatively few volatile alkaloids such as skytanthine.^{22, 13} This loss is clearly evident if one is standing a few yards away in a "down-wind" position from a field of catnip plants. Sukhov³⁷⁵ fed $^{14}\text{CO}_2$ to a whole pine tree and reported that label in the monoterpenes reached a maximum in 13 days and then declined. Cuttings of *Ocimum basilicum*²⁸¹ incorporated MVA-2- ^{14}C into the steam-volatile fraction with maximum radioactivity being incorporated after one hour which was followed by a rapid decline. Loomis²⁴⁶ found a maximum incorporation of $^{14}\text{CO}_2$ into peppermint monoterpenes after 6 hours, followed by a 15-fold decline in the next three hours. Baisted²⁶ has suggested that geraniol (XXII) is metabolized by the pea plant in a pathway other than the one involved in the biosynthesis of the higher terpenoids. In a time-course labeling study on the biosynthesis of the monoterpenoids produced by *Santolina chaemocypris* [which produces primarily artemisia ketone (XLV)] from MVA-2- ^{14}C , the per cent of radioactivity

incorporated reached a maximum value of 2.25 per cent after two days and at the end of fourteen days 1.25 per cent remained in the volatile oil fraction; however, certain of the monoterpenes, β -pinene (LXII) and myrcene (XXVIII), showed maximum incorporation at different times.^{406, 408}

In the diterpenoid alkaloid biosynthesis study,¹⁵⁶ it was found that young

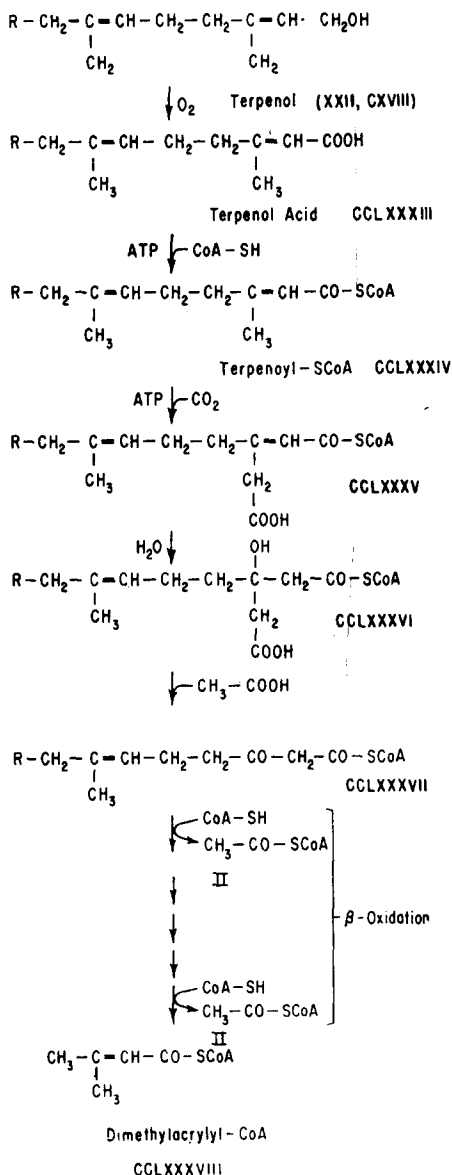
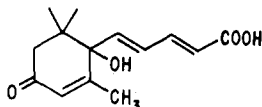

FIG. 45. Microbial degradation of geraniol and farnesol.³⁶⁷
 R = H; C₁₀ terpenol (geraniol). R = C₅H₁₁; C₁₅ terpenol (farnesol).

Delphinium ajacis plants contained predominantly alkaloids possessing low retention times on GLC as compared with older plants which contained components which had longer retention times, and the number of compounds with longer retention times increased as the plants approached maturity, with the largest component corresponding in retention time with delcosine (CLXIII). Such metabolic activity among alkaloids is beginning to be more widely recognized as studies on *Papaver somniferum* (poppy),¹⁵⁰ *Conium maculatum* (hemlock),¹⁵¹ *Nicotiana rustica* (tobacco),^{176, 177, 396} and *Ricinus communis* (castor bean)⁴⁰⁹ indicate.

Some metabolism of plant sterols has been indicated. A moderate rate of turnover in the production of β -amyirin (CLXX) was reported.² Tomatidine (CLXXXV) can be degraded by tomato fruits as they ripen,⁵⁵ and it was suggested that $\Delta^{16-5-\alpha}$ -pregnenolone (CLXXXVII) may be one of the products formed. The toxic triterpenoid pigment, gossypol (CLXXXIX), appears to be bound in the plant through: (a) the epsilon amino group of lysine,²⁵³ and (b) a hydrogen-bonded pigment.²⁶⁹ Translocation of gossypol within the cotton plant apparently occurs,³⁶³ but no clear indication of its metabolic activity has yet been demonstrated.

An ever-increasing number of terpenoids are being found to have an effect on "growth" as their primary biological activity tests indicate. The sesquiterpene, helminthosporal (CXXVII),^{181, 359, 377} isolated from the culture broth of the pathogenic fungus, *Helminthosporium sativum*, but not from higher plants, has been found to stimulate elongation in both dwarf and tall varieties of rice seedlings; however, it is not as effective as gibberellic acid. A terpenoid of unknown structure, Abscissin I,²⁴⁴ and the sesquiterpenoid Abscissin II (CCXC),^{290, 291}



Abscissin II
CCXC

are compounds that accelerate fruit and leaf abscission in a variety of plants. Growth inhibition and abscission occurs from both distal and proximal application of these compounds to plants.⁹⁸

Nine gibberellins (see Fig. 20, structure CXLIV, for example) have been well characterized and described in terms of their structure and biological activity; this subject has been reviewed recently by Paleg.²⁹⁵ These diterpenoid plant hormones stimulate cell division and cell elongation or perhaps both. Interconversion of gibberellins have been reported.⁴⁰¹

Pharbitis nil seedlings rapidly metabolize (—)-kaurene-17-¹⁴C, a gibberellin precursor (see Fig. 20, structure CLIII) administered to the cotyledons to compounds which do not correspond to gibberellins.⁵⁴ It was suggested that the kaurene metabolites were involved in photo-periodic floral induction. Of interest

is the finding that the enzymic catalysis of the cyclization of GGPP (XXI) to ultimately form (—)-kaurene is inhibited by synthetic growth retardants.¹³² Recently we have found delcosine (CLXIII) and an unknown diterpenoid alkaloid possessing a lycotoxine skeleton to be growth inhibitors;⁹² however, ajaconine (CLXII) was not inhibitory. It is interesting to speculate that certain of the diterpenoid alkaloids may serve as growth inhibitors by either inhibiting gibberellin biosynthesis (such as occurs with the synthetic growth inhibitors) in a "feed-back" type of control system or one in which growth is inhibited directly by the alkaloids. A proposed mechanism of action is shown in Fig. 46. Under certain conditions alkaloid synthesis by the plant may be favored over gibberellin synthesis. Preliminary results also indicate that terpenols have slight growth-inhibitory activity with the order of inhibition found being nerol > geraniol > linalool > farnesol > nerolidol.⁹²

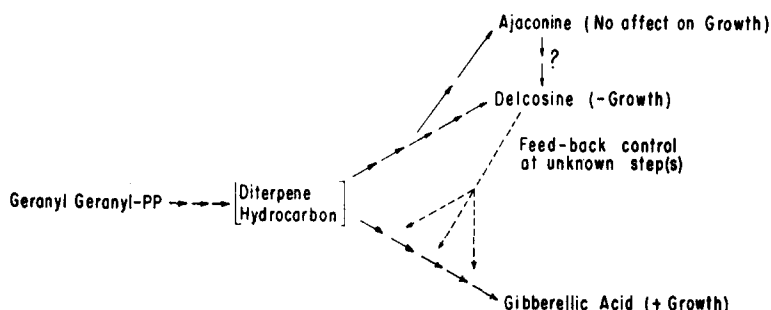
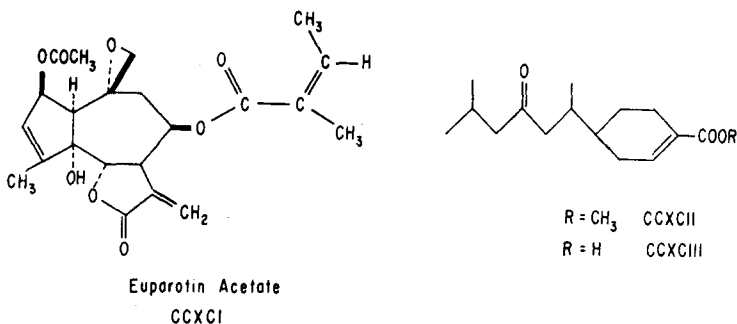

FIG. 46. Proposed relationship between diterpenoid alkaloids and gibberellins.

Goodwin¹⁷³ has summarized the evidence for the role of plant sterols (triterpenoids) being attached to particles in plants and suggests that they probably play the same part in the structure of membranes as they do in animals. Carotenoids function as accessory pigments and may also have a role in photosynthesis as an oxygen carrier. Phytol (CXLII), the side-chain of chlorophyll, is of the utmost significance because chlorophyll without its lipophilic moiety would be ineffective in photosynthesis.

As yet, it is not known if the polyprenols represent "end products of metabolism", or if they have a definite biological role in plant and/or animal development. Most of the silver birch wood polyprenols, and 50 per cent or more of the pig liver dolichols, are esterified in nature. The castaprenols isolated from horse chestnut leaves are unesterified. Esterification of an alcohol offers a biological method of inactivation or of converting that compound into a storage form. Factors controlling the extent of the chain length are not known. The Morton group^{273, 413} consider that the biosynthesis of the isoprenoid vitamins and chlorophyll, and cyclic di- and tetra-terpenoids, is linked to that of the *cis-trans*-polyprenols through the common intermediate all *trans*-geranylgeranylpyrophosphate. Bloch's group⁷ has recently isolated a long chain terpenylpyrophos-

phate synthetase from *Micrococcus lysodeikticus* which catalyzed the formation of polyprenols of $n = 7$ or $n = 8$ (C_{35} and C_{40} alcohols) and have suggested that these alcohols may provide the polyisoprenoid moiety of the bacterial quinone coenzyme. It will be interesting to see what develops concerning the biochemical control mechanism that determines whether these compounds will condense



with some aromatic non-isoprenoid compound, become partially saturated, undergo chain lengthening, etc. It would appear that since the polyprenols are so widespread in occurrence, they may play some important metabolic or physiologic role in the organism which produces them.

Finally, two recently isolated sesquiterpenoids that have widely differing kinds of biological activity have been reported. The first of these, euparotin acetate (CCXCI) from *Eupatorium rotundifolium* (a Florida plant), the most highly oxygenated guainolide known (it contains six oxygens), is an anti-tumor agent.²³² The second example is the discovery that the "paper factor" known to show strong juvenile hormone activity in *Pyrrhocoris apterus* (the hemipteran bug) is a sesquiterpenoid ester with structure CCXCII, called juvabione.⁷⁴

VI. CONCLUSIONS

It would require an extensive monograph to cover in detail all of the topics considered in this chapter. One of the most important features emerging from the various fields covered, such as chemistry, biochemistry, and plant physiology, is the interaction between disciplines. It is expected that as our knowledge advances, interdisciplinary approaches to solve basic biological problems, such as the ones encountered in the metabolism of terpenoids, will become an even more widely practised custom. It is hoped that this review will help stimulate research in some of the more neglected areas.

Received Dec. 6, 1967

VII. REFERENCES

1. ADAMS, R., GEISSMAN, T. A. and EDWARDS, G. D. *Chem. Revs.*, **60**, 555 (1960).
2. AEXEL, R., EVANS, S., KELLEY, M. and NICHOLAS, H. J. *Phytochem.*, **6**, 511 (1967).
3. AGRANOFF, B. W., EGGERER, H., HENNING, U. and LYNEN, F. *J. Am. Chem. Soc.*, **81**, 1254 (1959).
4. AGRANOFF, B. W., EGGERER, H., HENNING, U. and LYNEN, F. *J. Biol. Chem.*, **235**, 316 (1960).

5. AGURELL, S. *Acta Pharm. Suecica*, **3**, 71 (1966).
6. AKAZAWA, T. *Arch. Biochem. Biophys.*, **105**, 512 (1964).
7. ALLEN, C. M., ALWORTH, W., MACRAE, A. and BLOCH, K. *J. Biol. Chem.*, **242**, 1895 (1967).
8. ALSTON, R. E. and TURNER, B. L. *Biochem. Systematics*, p. 231. New Jersey: Prentice-Hall (1963).
9. AMDUR, B. H., RILING, H. and BLOCH, K. *J. Am. Chem. Soc.*, **79**, 2646 (1957).
10. AMELUNXEN, F. *Planta Med.*, **13**, 457 (1965).
11. AMELUNXEN, F. *Planta Med.*, **15**, 30 (1967).
12. ANDERSON, D. G. and PORTER, J. W. *Arch. Biochem. Biophys.*, **97**, 509 (1962).
13. APPEL, H. H. *Scientia*, **130**, 1 (1966).
14. ARCHER, B. L., AUDLEY, B. G., COCKBAIN, E. G. and MCSWEENEY, G. P. *Biochem. J.*, **89**, 565 (1963).
15. ARCHER, B. L., AYREY, G., COCKBAIN, E. G. and MCSWEENEY, G. P. *Nature*, **189**, 663 (1961).
16. ARCHER, B. L., BARNARD, D., COCKBAIN, E. G., CORNFORTH, J. W., CORNFORTH, RITA H. and POPIÁK, G. *Proc. Roy. Soc. B.*, **163**, 519 (1966).
17. ARIGONI, D. *Ciba Foundation Symposium on the Biosynthesis of Terpenes and Sterols*, p. 231. Boston: Little, Brown and Co. (1959).
18. ARIGONI, D. *Gazz. Chim. Ital.*, **92**, 884 (1962).
19. ARIGONI, D. *Symposium on Terpenoids in Plants* (ed. J. Pridham), London: Pergamon Press (1967).
20. ARREGUIN, B., BONNER, J. and WOOD, B. J. *Arch. Biochem. Biophys.*, **31**, 234 (1951).
21. ASAHIRA, Y. and ISHIDATE, M. *Ber. dtsh. Chem. Ges.*, **68**, 947 (1935).
22. AUDA, H., JUNEJA, H. R., EISENBRAUN, E. J., WALLER, G. R., KAYS, W. R. and APPEL, H. H. *J. Am. Chem. Soc.* **89**, 2476 (1967).
23. AUDA, H., WALLER, G. R. and EISENBRAUN, E. J. *J. Biol. Chem.*, **242**, 4157 (1967).
24. BADER, S., GUGLIEMETTI, L. and ARIGONI, D. *Proc. Chem. Soc.*, **6** (1964).
25. BAISTED, D. J., CAPSTACK, E., JR. and NES, W. R. *Biochemistry*, **1**, 537 (1962).
26. BAISTED, J. *Phytochem.*, **6**, 93 (1967).
27. BANDURSKI, R. and TEAS, H. J. *Plant Physiol.*, **32**, 643 (1957).
28. BARNARD, D. *Proc. Natural Rubber Producers Res. Assoc. Jubilee Conf.*, L. Mullins, ed., p. 89. London: Maclaren and Sons, Ltd. (1965).
29. BARTON, D. H. R. and DEMAYO, P. *Quart. Revs.*, **11**, 189 (1957).
30. BARTON, D. H. R., HARRISON, D. M. and MOSS, G. P. *Chem. Comm.*, **595** (1966).
31. BARTON, D. H. R. and MOSS, G. P. *Chem. Comm.*, **261** (1966).
32. BATE-SMITH, E. C. and SWAIN, T. *Comparative Phytochemistry*, T. Swain, ed., p. 159. New York: Academic Press (1966).
33. BATES, R. B., EISENBRAUN, E. J. and McELVAIN, S. M. *J. Am. Chem. Soc.*, **80**, 3420 (1958).
34. BATES, R. B. and PAKNIKAR, S. K. *Tetrahedron Letters*, **1453** (1965).
35. BATAILLE, J. and LOOMIS, W. D. *Biochim. Biophys. Acta*, **51**, 545 (1961).
36. BATTERSBY, A. R. *IUPAC International Symposium on the Chemistry of Natural Products in Stockholm, Sweden, June 23-July 2, 1966*, Vol. 4 (in press).
37. BATTERSBY, A. R., BROWN, R. T., KAPIL, R. S., KNIGHT, J. A., MARTIN, J. A. and PLUNKETT, A. O. *J. Am. Chem. Soc.*, **2**, 810 (1966).
38. BATTERSBY, A. R., BROWN, R. T., KAPIL, R. S., MARTIN, J. A. and PLUNKETT, A. O. *Chem. Comm.*, **2**, 812 (1966).
39. BATTERSBY, A. R., BROWN, R. T., KAPIL, R. S., PLUNKETT, A. O. and TAYLOR, J. B. *Chem. Comm.*, **2**, 47 (1966).
40. BATTERSBY, A. R., BROWN, R. T., KNIGHT, J. A., MARTIN, J. A. and PLUNKETT, A. O. *Chem. Comm.*, **2**, 346 (1966).
41. BATTERSBY, A. R. and PARRY, G. V. *Tetrahedron Letters*, 787 (1964).
42. BATTU, R. G. and YOUNGKEN, H. W. *Lloydia*, **29**, 360 (1966).
43. BEELER, D. A., ANDERSON, D. G. and PORTER, J. W. *Arch. Biochem. Biophys.*, **102**, 26 (1963).
44. BEELER, D. A., and PORTER, J. W. *Biochem. Biophys. Res. Commun.*, **8**, 367 (1962).
45. BENN, M. H. and MAY, J. *Experientia*, **20**, 252 (1964).
46. BENNETT, R. D. and HEFTMANN, E. *Arch. Biochem. Biophys.*, **112**, 616 (1965).
47. BENNETT, R. D. and HEFTMANN, E. *Phytochem.*, **4**, 475 (1965).
48. BENNETT, R. D. and HEFTMANN, E. *Phytochem.*, **4**, 577 (1965).
49. BENNETT, R. D. and HEFTMANN, E. *Phytochem.*, **5**, 747 (1966).
51. BENNETT, R. D., HEFTMANN, E. and S.-T. KO. *Phytochem.*, **5**, 517 (1966).

52. BENNETT, R. D., HEFTMANN, E., PRESTON, W. H., JR. and HAUN, J. R. *Arch. Biochem. Biophys.*, **103**, 74 (1963).
53. BENNETT, R. D., S.-T. KO and HEFTMANN, E. *Phytochem.*, **5**, 231 (1966).
54. BENNETT, R. D., S.-T. KO and HEFTMANN, E. *Plant Physiol.* **41**, 1360 (1966).
55. BENNETT, R. D., LIEBER, E. R. and HEFTMANN, E. *Phytochem.*, **6**, 837 (1967).
56. BENVENISTE, P., HIRTH, L. and OURISSON, G. *Phytochem.*, **5**, 45 (1966).
57. BERNARD, M., VALENTINE, C. and REID, W. W. *Tobacco Research Conference*, Canberra, Australia. Abstracts, from Ref. 284 (1964).
58. BHATTACHARYYA, P. K. and DHAVALIKAR, R. S. *Ind. J. Biochem.*, **2**, 73 (1966).
59. BIELIG, H. J. and HAYASHIDA, A. *Hoppe-Seyl. Z.*, **266**, 99 (1940).
60. BIRCH, A. J. *Proc. Chem. Soc.*, **3** (1962).
61. BIRCH, A. J., BOULTER, D., FRYER, R. I., THOMSON, P. J. and WILLIS, J. L. *Tetrahedron Letters*, **3**, 1 (1959).
62. BIRCH, A. J., CAMERON, D. W., HOLZAFEL, C. W. and RICKARDS, R. W. *Chem. and Ind. (London)*, 374 (1963).
63. BIRCH, A. J., ENGLISH, R. J., MASSY-WESTROPP, R. A. and SMITH, H. J. *Chem. Soc.*, 369 (1958).
64. BIRCH, A. J., KOCOR, M., SHEPPARD, N. and WINTER, J. J. *Chem. Soc.*, 1502 (1962).
65. BIRCH, A. J., RICKARDS, R. W. and SMITH, H. *Proc. Chem. Soc.*, 192 (1958).
66. BIRCH, A. J., RICKARDS, R. W., SMITH, H., HARRIS, A. and WHALLEY, W. B. *Tetrahedron*, **7**, 241 (1959).
67. BLOCH, K., CHAYKIN, S., PHILLIPS, A. H. and DEWAARD, A. J. *Biol. Chem.*, **234**, 2595 (1959).
68. BLOCH, K. and RITTENBERG, D. *J. Biol. Chem.*, **155**, 243 (1944).
69. BOATNER, C. H., HALL, C. M., O'CONNOR, R. T. and CASTILLION, L. E. *Bot. Gaz.*, **109**, 108 (1947).
70. BOATNER, C. H., HALL, C. M., ROLLINS, M. L. and CASTILLION, L. E. *Bot. Gaz.*, **108**, 484 (1947).
71. BOITEAU, P., PASICH, B. and RATISMAMANGA, A. R. *Les Triterpénoides en Physiologie Végétale et Animale*, Paris: Gauthier-Villars (1964).
72. BONNER, J. *Biogenesis of Natural Compounds*, p. 727. New York: The Macmillan Co. (1963).
73. BONNER, J. *Plant Biochemistry*, J. Bonner and J. E. Varner, Eds., p. 665. New York: Academic Press (1965).
74. BOWERS, W. S., FALES, H. M., THOMPSON, M. J. and UEBAL, E. C. *Science*, **154**, 1020 (1966).
75. BOYLAND, E. *Biochem. J.*, **34**, 1200 (1940).
76. BRAITHWAITE, G. D. and GOODWIN, T. W. *Biochem. J.*, **76**, 1, 5, 194 (1960).
77. BRECCIA, A. and ABBONDANZA, A. *Z. Naturforsch.*, **22b**, 50 (1967).
78. BRECCIA, A. and BADIELLO, R. *Z. Naturforsch.*, **22b**, 44 (1967).
79. BRITT, J. J. and ARIGONI, D. *Proc. Chem. Soc.*, 224 (1958).
80. BRODIE, B. B. *Ciba Foundation Symposium on Enzyme Drug Action*, J. L. Mongar and A. R. S. deRevok, ed., p. 317. Boston: Little, Brown, and Co. (1962).
81. BRODIE, J. D. and PORTER, J. W. *Biochem. Biophys. Res. Commun.*, **3**, 173 (1960).
82. BRODIE, J. D., WASSON, G. and PORTER, J. W. *Biochem. Biophys. Res. Commun.*, **12**, 27 (1963).
83. BRODIE, J. D., WASSON, G. and PORTER, J. W. *J. Biol. Chem.*, **238**, 1294 (1963).
84. BRODIE, J. D., WASSON, G. and PORTER, J. W. *J. Biol. Chem.*, **239**, 1346 (1964).
85. BRUNS, K. Dissertation cited in ref. 411.
86. BUCHER, N. A. R., OVERATH, P. and LYNEN, F. *Biochim. Biophys. Acta*, **40**, 491 (1960).
87. BU'LOCK, J. D. *The Biosynthesis of Natural Products*, p. 46. New York: McGraw-Hill Publishing Company, Ltd. (1965).
88. BURBOTT, A. J. and LOOMIS, W. D. *Plant Physiol.*, **42**, 20 (1967).
89. BURGOS, J., BUTTERWORTH, P. H. W., HEMMING, F. W. and MORTON, R. A. *Biochem. J.*, **91**, 22P (1964).
90. BURGOS, J., HEMMING, F. W., PENNOCK, J. F. and MORTON, R. A. *Biochem. J.*, **88**, 470 (1963).
91. BURNETT, J. H. In *Chem. Biochem. Plant Pigments*, T. W. Goodwin, ed., p. 75. New York: Academic Press (1965).
92. BURSTRÖM, H. and WALLER, G. R. Unpublished results.

93. BUTTERWORTH, P. H. W., DRAPER, H. H., HEMMING, F. W. and MORTON, R. A. *Arch. Biochem. Biophys.*, **113**, 646 (1966).
94. BUTTERWORTH, P. H. W., DRAPER, H. H., HEMMING, F. W., PENNOCK, J. F. and MORTON, R. A. *Biochem. J.*, **89**, 32P (1963).
95. CAPSTACK, E., JR., BAISTED, D. J., NEWSCHWANDER, W. W., BLONDIN, G., ROSIN, N. L. and NESS, W. R. *Biochemistry*, **1**, 1178 (1962).
96. CAPSTACK, E., JR., ROSIN, N., BLONDIN, G. A. and NES, W. R. *J. Biol. Chem.*, **240**, 3258 (1965).
97. CARLQUIST, S. *Am. J. Botany*, **45**, 675 (1958).
98. CARNS, H. R. *Ann. Rev. Plant. Physiol.*, L. Machlis, W. R. Briggs and R. B. Park, eds., p. 295. *Ann. Revs., Inc.*: Palo Alto, California, Vol. 17 (1966).
99. CASINOVI, C. G., GIOVANNOZZI-SERMANNI, G. and MARINI-BETTOLO, G. B. *Gazz. Chim. Ital.*, **94**, 1356 (1964).
100. CASINOVI, C. G. and MARINI-BETTOLO, G. B. *IUPAC Meeting*, London, Abstract Ab-3, p. 285 (1963).
101. CASPI, E. *4th International Symposium on the Chemistry of Natural Products*, Stockholm, Sweden, June 26-July 2, Abstract, p. 135 (1966).
102. CASPI, E., LEWIS, D. O., PIATAK, D. M., THIMANN, K. V. and WINTER, A. *Experientia*, **22**, 506 (1966).
103. CASTLE, M., BLONDIN, G. and NES, W. R. *J. Am. Chem. Soc.*, **85**, 3306 (1963).
104. CAVILL, G. W. K. *Rev. Pure Applied Chem.*, **10**, 169 (1960).
105. CAVILL, G. W. K. and HINTENBERGER, H. *Aust. J. Chem.*, **13**, 514 (1960).
106. CAVILL, G. W. K. and ROBERTSON, PHYLLIS L. *Science*, **149**, 1337 (1965).
107. CHAFMAN, P. J., MEERMAN, G., GUNSALUS, I. C., SRINIVASAN, R. and RINEHART, K. L., JR. *J. Am. Chem. Soc.*, **88**, 618 (1966).
108. CHAYKIN, S., LAW, J., PHILLIPS, A. H., TCHEN, T. T. and BLOCH, K. *Proc. Natl. Acad. Sci. U.S.*, **44**, 998 (1958).
109. CHICHESTER, C. O. and NAKAYAMA, T. O. M. In *Biogenesis of Natural Compounds*, P. Bernfeld, ed., p. 475. New York: Pergamon Press (1963).
110. CHRISTOPHE, J. and POPIÁK, G. *J. Lipid Res.*, **2**, 244 (1961).
111. CLARK, K. J., GRAY, G. I., JAEGER, R. J. and ROBINSON, SIR ROBERT. *Tetrahedron*, **6**, 217 (1959).
112. CLAYTON, R. B. *Quart. Rev.*, **19**, 168, 201 (1965).
113. CONRAD, H. E., DUBUS, R., NAMVEDT, M. J. and GUNSALUS, I. C. *J. Biol. Chem.*, **240**, 495 (1965); see also preceding papers.
114. CONRAD, H. E., HEDEGAARD, J. and GUNSALUS, I. C. *Tetrahedron Letters*, 561 (1965).
115. CONRAD, H. E., LIEB, K. and GUNSALUS, I. C. *J. Biol. Chem.*, **240**, 4029 (1965).
116. COON, M. J., KUPIECKI, F. P., DEKKAR, E. E., SCHLESINGER, M. J. and DEL CAMPILLO, ALICE. In the *Ciba Foundation Symposium on the Biosynthesis of Terpenes and Sterols*, p. 62. Boston: Little, Brown and Co. (1959).
117. COOPER, C. Z. and BENEDICT, C. R. *Plant Physiol.*, **42**, 515 (1967).
118. COREY, E. J., RUSSEY, W. E., ORTIZ, R. P. and MONTELLANE, O. *J. Am. Chem. Soc.*, **88**, 4750, 4751 (1966).
119. CORNFORTH, J. W. *Pure Appl. Chem.*, **2**, 607 (1961).
120. CORNFORTH, J. W., CORNFORTH, F. R. S., CORNFORTH, R. H., DONNINGER, C. and POPIÁK, G. *Proc. Roy. Soc. (London) B*, **163**, 492 (1966).
121. COSCIA, C. J. Personal communication.
122. COSCIA, C. J. and GUARNACCIA, R. *J. Am. Chem. Soc.*, **89**, 1280 (1967).
123. COSTES, C. *Phytochem.*, **5**, 311 (1966).
124. CROSS, B. E., GALT, R. H. B. and HANSEN, J. R. *J. Chem. Soc.*, 295 (1964).
125. CROSS, B. E., GROVE, J. F., MACMILLAN, J. and MULHOLLAND, T. P. C. *Chem. and Ind.*, 954 (1956).
126. CROWLEY, M. P., GODIN, P. J., INGLIS, H. S., SNAREY, M. and THAIN, E. M. *Biochim. Biophys. Acta*, **60**, 312 (1962).
127. DAUBEN, W. G., BAN, Y. and RICHARDS, J. H. *J. Am. Chem. Soc.*, **79**, 968 (1957).
128. DAUBEN, W. G., FONKEN, G. J. and BOSWELL, G. A. *J. Am. Chem. Soc.*, **79**, 1000 (1957).
129. DAVIES, B. H., JONES, D. and GOODWIN, T. W. *Biochem. J.*, **87**, 326 (1963).
130. DEKKER, E. E., SCHLESINGER, M. J. and COON, M. J. *J. Biol. Chem.*, **233**, 434 (1958).
131. DEMAYO, P., ROBINSON, J. R., SPENCER, E. Y. and WHITE, R. W. *Experientia*, **18**, 359 (1962).

132. DENNIS, D. T., UPPER, C. D. and WEST, C. A. *Plant Physiol.*, **40**, 948 (1965).
133. DEVYS, M. and BARBIER, M. *Phytochem.*, **5**, 1031 (1966).
134. DEWAARD, A., PHILLIPS, A. H. and BLOCH, K. J. *Am. Chem. Soc.*, **81**, 2913 (1959).
135. DHAVALIKAR, R. S. and BHATTACHARYYA, P. K. *Ind. J. Biochem.*, **3**, 144 (1966). See also other papers in this series.
136. DICKENSON, P. B. *The Chemistry and Physics of Rubber-like Substances*, p. 45. London: Maclaren Press (1963).
137. DONNINGER, C. and RYBACK, G. *Biochem. J.*, **91**, 11P (1964).
138. DUGAN, J. J., DEMAYO, P., NISBET, M., ROBINSON, J. R. and ANCHEL, M. *J. Am. Chem. Soc.*, **88**, 2838 (1966).
139. DUNPHY, P. J., KERR, J. D., PENNOCK, J. F., WHITTLE, K. J. and FEENEY, J. *Biochim. Biophys. Acta*, **136**, 136 (1967).
140. DURR, I. F. and RUDNEY, H. *J. Biol. Chem.*, **235**, 2572 (1960).
141. EARHARDT, J. D., HIRTH, L. and OURISSON, G. *Phytochem.*, **6**, 815 (1967).
142. EIMHJELLEN, K. E. and JENSEN, S. L. *Biochim. Biophys. Acta*, **82**, 21 (1964).
143. EISENBRAUN, E. J., BRIGHT, A. and APPEL, H. H. *Chem. Ind. (London)*, 1242 (1962).
144. EISENBRAUN, E. J., HORODYSKY, A. G. and WALLER, G. R. Results presented at 6th Ann. Mtg. Plant Phenolics Group North America, Austin, Texas, April 6-8 (1966).
145. EISENBRAUN, E. J., WALLER, G. R. and APPEL, H. H. *Manuscript in preparation*.
146. EISNER, T. *Science*, **146**, 1318 (1965).
147. EISNER, T. *Science*, **148**, 966 (1965).
148. ELBER, R., Dissertation, Basel (1964); from Von Euw, J. and Reichstein, T., *Helv. Chim. Acta*, **47**, 711 (1964).
149. ELDJARN, L., TRY, K. and STORKE, O. *Biochim. Biophys. Acta*, **116**, 395 (1966).
150. FAIRBAIRN, J. W. and PATERSON, A. *Nature*, **210**, 1163 (1966).
151. FAIRBAIRN, J. W. and SUWAL, P. N. *Phytochem.*, **1**, 38 (1961).
152. FISCHER, F. G. and BIELIG, H. J. *Hoppe-Seyl. Z. Physiol. Chem.*, **266**, 73 (1940).
153. FOLKERS, K., SHUNK, C. H., LINN, B. O., ROBINSON, F. M., WITTRICH, P. E., HUFF, J. W., GILFILLAN, J. L. and SKEGGS, H. R. In the *Ciba Foundation Symposium on the Biosynthesis of Terpenes and Sterols*, p. 20, Boston: Little, Brown and Co. (1959).
154. FRAENKEL, G. *Science*, **129**, 1466 (1959).
155. FRIIS, P., DAVES, G. D., JR. and FOLKERS, K. *J. Am. Chem. Soc.*, **88**, 4754 (1966).
156. FROST, G. M., HALE, R. L., WALLER, G. R., ZALKOW, L. H. and GIROTRA, N. N. *Chem. and Ind.*, 320 (1967).
157. FUSCO, R., TRAVE, R. and VERCELLONE, A. *Chimica e industria (Milan)*, **37**, 251 (1955).
158. GATTI, G. and MAROTTA, M. *Ann. Inst. Super. di Sanita*, **2**, 29 (1966).
159. GEISSMAN, T. A., VERBISCAR, A. J., PHINNEY, B. O. and CRAGG, G. *Phytochem.*, **5**, 933 (1966).
160. GLOOR, U. and WISS, O. *Arch. Biochem. Biophys.*, **83**, 216 (1959).
161. GLOVER, J. *Biochemistry of Quinones*, p. 207. New York: Academic Press (1965).
162. GOAD, L. J. and GOODWIN, T. W. *Biochem. J.*, **96**, 8P (1965).
163. GOAD, L. J., HAMMAM, A. S. A., DENNIS, A. and GOODWIN, T. W. *Nature*, **210**, 1322 (1966).
164. GODIN, P. J. and THAIN, E. M. *Proc. Chem. Soc.*, 452 (1961).
165. GOEGGEL, H. and ARIGONI, D. *Chem. Comm.*, **2**, 538 (1965).
166. GOLD, P. H. and OLSON, R. E. *J. Biol. Chem.*, **241**, 3507 (1966).
167. GOODWIN, T. W. *The Biosynthesis of Vitamins and Related Compounds*, p. 245. New York: Academic Press (1963).
168. GOODWIN, T. W. In *Biosynthetic Pathways in Higher Plants*, J. B. Pridham and T. Swain, eds., p. 37. New York: Academic Press (1965).
169. GOODWIN, T. W. In *Biosynthetic Pathways in Higher Plants*, J. B. Pridham and T. Swain, eds., p. 57. London: Academic Press (1965).
170. GOODWIN, T. W. In *Chem. Biochem. Plant Pigments*, T. W. Goodwin, ed., p. 143. New York: Academic Press (1965).
171. GOODWIN, T. W. and WILLIAMS, R. J. H. *Biochem. J.*, **94**, 5C (1965).
172. GOODWIN, T. W. and WILLIAMS, R. J. H. *Proc. Roy. Soc. B* **163**, 515 (1966).
173. GOODWIN, T. W. in *Terpenoids in Plants*, J. B. Pridham, ed., London: Academic Press, (1967).
174. GOULD, R. G. and POPJÁK, G. *Biochem. J.*, **66**, 51P (1957).
175. GRAEBE, J. E., DENNIS, D. T., UPPER, C. D. and WEST, C. A. *J. Biol. Chem.*, **240**, 1847 (1965).

176. GRIFFITH, G. D. and GRIFFITH, T. *Plant Physiol.*, **39**, 970 (1964).
177. GRIFFITH, G. D., GRIFFITH, T. and BYERRUM, R. U. *J. Biol. Chem.*, **235**, 3536 (1960).
178. GROB, E. C. and BÜTLER, R. *Helv. Chim. Acta*, **37**, 1908 (1954).
179. GROB, E. C. and BÜTLER, R. *Helv. Chim. Acta*, **38**, 1313 (1955).
180. GROB, E. C. and BÜTLER, R. *Helv. Chim. Acta*, **39**, 1975 (1956).
181. GROB, E. C., KIRSCHNER, K. and LYNEN, F. *Chimia*, **15**, 308 (1961).
182. GROS, E. G. and LEETE, E. *J. Am. Chem. Soc.*, **87**, 3479 (1965).
183. HAAGEN-SMIT, A. J. and NIMMO, C. C. *Comprehensive Biochemistry*, **9**, 115 (1963).
184. HALL, E. S., McCAPRA, F., MONEY, T., FUKUMOTO, K., HANSON, J. R., MOOTOO, B. S., PHILLIPS, G. T. and SCOTT, A. I. *Chem. Comm.* **2**, 348 (1966).
185. HALL, R. H., ROBINS, M. J., STASIUK, L. and THEDFORD, R. *J. Am. Chem. Soc.*, **88**, 2614 (1966).
186. HAMÄLÄINEN, J. *Biochem. Z.* **41**, 241 (1912).
187. HAMMOUDA, Y. and AMER, M. S. *J. Pharm. Sci.*, **55**, 1452 (1966).
188. HAMMOUDA, Y. and LE MEN, J. *Bull. Soc. Chim. Fr.* 2901 (1963).
189. HAMMOUDA, Y., PLAT, M. and LE MEN, J. *Bull. Soc. Chim. Fr.* 2802 (1963).
190. HANOVER, J. W. *Phytochem.*, **5**, 713 (1966).
191. HANSEN, R. P., SHORLAND, F. B. and MORRISON, J. D. *J. Dairy Res.*, **32**, 21 (1965).
192. HANSEN, R. P., SHORLAND, F. B. and PRIOR, I. A. M. *Biochim. Biophys. Acta*, **116**, 178 (1966).
- 192a. HAPP, G. M. and MEINWALD, J. *J. Am. Chem. Soc.*, **87**, 2507 (1965).
193. HARVEY, J. M. *University of Queensland Papers*, **1**, No. 23, from ref. 420 (1942).
194. HEDEGAARD, J. and GUNSAALUS, I. C. *J. Biol. Chem.*, **240**, 4038 (1965).
195. HEFENDEHL, F. W. *Planta Medica*, **14**, 66 (1966).
196. HEFENDEHL, F. W., UNDERHILL, E. W. and VON RUDLOFF, E. *Phytochem.*, **6**, 823 (1967).
- 196a. HEFENDEHL, F. W. *Planta Medica*, **15**, 121 (1967).
197. HEFTMAN, E., S.-T. KO and BENNETT, R. D. *Naturwissenschaften*, **52**, 431 (1965).
198. HEFTMAN, E., S.-T. KO and BENNETT, R. D. *Phytochem.*, **6**, 1337 (1966).
199. HEFTMAN, E., LIEBER, E. R. and BENNETT, R. D. *Phytochem.*, **6**, 225 (1967).
200. HEINSTEIN, P. F., SMITH, F. H. and TOVE, S. B. *J. Biol. Chem.*, **237**, 2643 (1962).
- 200a. HEINSTEIN, P. F., Ph.D. Dissertation, North Carolina State University, Raleigh (1967).
201. HEMMING, F. W., MORTON, R. A. and PENNOCK, J. F. *Proc. Roy. Soc. B*, **158**, 291 (1963).
202. HENNING, U., MOSLEIN, E. H. and LYNEN, F. *Arch. Biochem. Biophys.*, **83**, 259 (1959).
203. HERBERT, E. J. and KIRBY, G. W. *Tetrahedron Letters*, 1505 (1963).
204. HILDEBRANDT, H. *Arch. exp. Path. Pharmacol.*, **45**, 110 (1901) (from ref. 420).
205. HILDEBRANDT, H. *Hoppe-Seyl. Z.* **36**, 141, 457 (1902).
206. HILDEBRANDT, H. *Beitr. chem. Physiol. Path.*, **4**, 251 (1904), (from ref. 420).
207. HOLNESS, N. J. and GRAY, C. H. *J. Endocrin.*, **17**, 237 (1958).
208. HOLTZ, A. H. *Nature*, **174**, 316 (1954).
209. HORODYSKY, A. G. *The Biosynthesis of Verbenalin*, Ph.D. Thesis, Oklahoma State University, May 1967.
210. HOWE, K. J. and STEWARD, F. C. *Cornell Univ. Agr. Expt. Sta. Mem.* **379**, 11 (1962).
211. HUNI, J. E. S., HILTEBRAND, H., SCHMID, H., GROGER, D., JOHNE, S. and MOTHES, K. *Experientia*, **22**, 656 (1966).
212. JAUREGUIBERRY, G., LAW, J. H., McCLOSKEY, J. A. and LEDERER, E. *Biochemistry*, **4**, 347 (1965).
213. JENSEN, S. L. and JENSEN, A. in *Progress in the Chemistry of Fats and Other Lipids*, Vol. 8, pp. 129-212. London and New York: Pergamon Press (1966).
214. JOHNSON, D. F., BENNETT, R. D. and HEFTMAN, E. *Science*, **140**, 198 (1963).
215. JOHNSON, D. F., WATERS, J. A. and BENNETT, R. D. *Arch. Biochem. Biophys.*, **108**, 282 (1964).
216. JOHNSON, D. F., WRIGHT, B. E. and HEFTMAN, E. *Arch. Biochem. Biophys.*, **97**, 232 (1962).
217. JOHNSTON, J. A., RACUSEN, D. W. and BONNER, J. *Proc. Natl. Acad. Sci. U.S.A.*, **40**, 1031 (1954).
218. JONES, E. R. H. and LOWE, G. *J. Chem. Soc.*, **3959** (1960).
219. JONES, G., FALES, H. M. and WILDMAN, W. C. *Tetrahedron Letters*, 397 (1963).
- 219a. JUNGALWALA, F. B., and PONTEN, J. W. *Arch. Biochem. Biophys.*, **119**, 209 (1967).
220. KAKURANI, Y. *J. Biochem. (Japan)*, **59**, 135 (1966).
221. KANDUTSCH, A. A., PAULUS, H., LEVEN, E. and BLOCH, K. *J. Biol. Chem.*, **239**, 2507 (1964).
222. KEKURICK, R. G. O., ARCHER, B. L., BARNARD, D., HIGGINS, G. M. C., McSWEENEY, G. P. and MOORE, C. G. *Nature*, **184**, 268 (1959).

223. KIRTLEY, M. E., RUDNEY, H. and DURR, I. F. *J. Biol. Chem.*, **237**, 1781 (1962).
224. KLENK, E. and KOHLKE, W. *Hoppe-Seyl. Z. Physiol. Chem.*, **333**, 133 (1963).
225. KLENK, E. and KREMER, G. J. *Hoppe-Seyl. Z. Physiol. Chem.*, **343**, 39 (1965).
226. KNAUSS, H. J., BRODIE, J. D. and PORTER, J. W. *J. Lipid Res.*, **3**, 197 (1962).
227. KOWANKO, N. and LEETE, E. *J. Am. Chem. Soc.*, **84**, 4919 (1962).
228. KREMER, G. J. *Klin. Wochschr.*, **43**, 517 (1965).
229. KÜHN, R., KÖHLER, F. and KÖHLER, L. *Hoppe-Seyl. Z. Physiol. Chem.*, **242**, 171 (1936).
230. KÜHN, R. and LIVADA, K. *Beitr. chem. Physiol. Path.*, **220**, 235 (1933) (from ref. 420).
231. KÜHN, R. and LOW, I. *Hoppe-Seyl. Z. Physiol. Chem.*, **254**, 139 (1938).
232. KUPCHAN, S. M., HEMINGWAY, J. C., CASSADY, J. M., KNAT, J. R., MEPHAIL, A. T. and SIM, G. A. *J. Am. Chem. Soc.*, **89**, 465 (1967); see also *Chem. Eng. News*, Jan. 23, p. 34 (1967).
233. KURIHARA, K., KATO, Y., KAKEI, Y. and SHICHIJI, S. *Kogyo Gijutsuin, Hakko Kenkyusho Kenkyu Hokoku*, No. 25, 33, from *Chem. Abs.* **64**, 20269 (1966).
234. LAWSON, D. E. M., MERCER, E. I., GLOVER, J. and MORTON, R. A. *Biochem. J.*, **74**, 38P (1960).
235. LEBOEUF, M., CAVE, A. and GOUTAREL R. *Compt. Rend.*, **259**, 3401 (1964).
236. LEDERER, E. *France Parfums*, **3**, 28; *Chem. Abs.*, **54**, 14579 (1960).
237. LEDERER, E. *Biochem. J.*, **93** 449 (1964).
238. LEDERER, M. E. *Bull. Soc. Chim. Biol.*, **25**, 1381 (1943).
239. LEETE, E., GREGORY, H. and GROS, E. G. *J. Am. Chem. Soc.*, **87**, 3475 (1965).
240. LEETE, E. and WEMPLE, J. N. *J. Am. Chem. Soc.*, **88**, 4743 (1966).
241. LEVY, H. R. and POPIÁK, G. *Biochem. J.*, **75**, 417 (1960).
242. LINDBERG, M., YUAN, C., DEWAARD, A. and BLOCH, K. *Biochemistry*, **1**, 182 (1962).
243. LINDGREN, B. O. *Acta Chem. Scand.*, **19**, 1317 (1965).
244. LIU, W. C. and CARNS, H. R. *Science*, **134**, 384 (1961).
245. LOEW, P., GOEGGEL, H. and ARIGONI, D. *Chem. Comm.*, **2**, 347 (1966).
246. LOOMIS, W. D. *Terpenoids in Plants*, J. Fridham, ed., p. 59. London: Pergamon Press (1967).
247. LOOMIS, W. D. and BATTAILE, J. *Biochim. Biophys. Acta*, **67**, 54 (1963).
248. LOOMIS, W. D. and BATTAILE, J. *Phytochem.*, **5**, 423 (1966).
249. LOOMIS, W. D. and BURBOTT, ALICE J. Personal communication.
250. LOOMIS, W. D., WICK, L. B., GARDNER, R. L. and DANKLEFF, MARY. *4th International Symposium on the Chemistry of Natural Products*, Stockholm, June 26–July 2, abstract, p. 141 (1966).
251. LOUGH, A. K. *Biochem. J.*, **91**, 584 (1964).
252. LOWRY, L. K. and CHICHESTER, C. O. *Phytochem.*, **6**, 367 (1967).
253. LYMAN, C. M., BALIGA, B. D. and SLAY, M. *Arch. Biochem. Biophys.*, **84**, 486 (1959).
254. LYMAN, C. M., EL-NOCKRASHY, A. S. and DOLLAHITE, J. W. *Science*, **138**, 992 (1962).
255. LYNEN, F. In *Ciba Foundation Symposium on the Biosynthesis of Terpenes and Sterols*, p. 95. Boston: Little, Brown and Co. (1959).
256. LYNEN, F., AGRANOFF, B. W., EGGERER, H., HENNING, U. and MOSLEIN, E. M. *Angew. Chem.*, **71**, 657 (1959).
257. LYNEN, F., EGGERER, H., HENNING, U. and KESSEL, I. *Angew. Chem.*, **70**, 738 (1958).
258. LYNEN, F. and HENNING, U. *Angew. Chem.*, **70**, 820 (1960).
259. LYNEN, F. and HENNING, U. *Angew. Chem.*, **72**, 820 (1960).
260. LYNEN, F., HENNING, U., BUBLITZ, C., SORBO, B. and KROPLIN-RUEFF, L. *Biochem. Z.*, **330**, 269 (1958).
261. McCAPRA, F., MONEY, T., SCOTT, A. I. and WRIGHT, I. G., *Chem. Comm.*, **1**, 537 (1965).
262. McCONNELL, J. F., MATHIESON, A. McL. and SCHOENBORN, B. P. *Tetrahedron Letters*, 445 (1962).
263. McELVAIN, S. M., BRIGHT, R. D. and JOHNSON, P. R. *J. Am. Chem. Soc.*, **63**, 1558 (1941).
264. McELVAIN, S. M., WALTERS, P. M. and BRIGHT, R. D. *J. Am. Chem. Soc.*, **64**, 1828 (1942).
265. McMULLEN, A. I. *Biochem. J.*, **85**, 491 (1962).
266. MATTHILL, H. A. *The Vitamins*, p. 483. New York: Academic Press (1954).
267. MEINWALD, J., CHADHA, M. S., HURST, J. J. and EISNER, T. *Tetrahedron Letters*, 29 (1962).
268. MERCER, E. I., DAVIES, B. H. and GOODWIN, T. W. *Biochem. J.*, **87**, 317 (1963).
269. MERCER, E. I. and GOODWIN, T. W. *Biochem. J.*, **88**, 46P (1963).
270. MILLER, J. A. and WOOD, H. C. S. *Angew. Chem. Int. Ed.*, **3**, 310 (1964).
271. MITSUHASHI, H., KANEKO, K., EGUCHI, S. and OTSU, M. *Yakugaku Zasshi*, **80**, 268 (1960); via *Chem. Abs.*, **54**, 21343 (1960).

272. MIZE, C., AVIGAN, J., BAXTER, J. H., FALES, H. and STEINBERG, D. *J. Lipid Res.*, **7**, 692 (1966).
273. MORTON, R. A. *Biochemistry of Quinones*, New York: Academic Press (1965).
274. MURRAY, M. J. *Genetics*, **45**, 925 (1960).
275. MURRAY, M. J. *Genetics*, **45**, 931 (1960).
276. NANDI, D. L. and PORTER, J. W. *Arch. Biochem. Biophys.*, **105**, 7 (1964).
277. NES, W. R. and RUSSELL, P. T. *Federation Proc.*, **25**, 222 (1966).
278. NICHOLAS, H. J. Personal communication.
279. NICHOLAS, H. J. *J. Biol. Chem.*, **237**, 1476 (1962).
280. NICHOLAS, H. J. *J. Biol. Chem.*, **237**, 1481 (1962).
281. NICHOLAS, H. J. *J. Biol. Chem.*, **237**, 1485 (1962).
282. NICHOLAS, H. J. in *Biogenesis of Natural Compounds*, P. Bernfeld, p. 641. New York: The Macmillan Co. (1963).
283. NICHOLAS, H. J. *Biochim. Biophys. Acta*, **84**, 80 (1964).
284. NICHOLAS, H. J. In *Comprehensive Biochemistry*, **20**, M. Florkin and E. H. Stotz. New York: Elsevier Publishing Co., in press (1967).
285. NICHOLAS, H. J. In *Biogenesis of Natural Compounds*, P. Bernfeld, ed., p. 659 for earlier schemes. New York: The Macmillan Co. (1963).
286. NICHOLAS, H. J. *Phytochem.*, **7**, 371 (1967).
287. NICHOLS, B. W. *Biochim. Biophys. Acta*, **70**, 417 (1963).
288. ODELL, G. V., Ph.D. Dissertation, Texas A. and M. University, August 1966.
289. ODELL, G. V., CHANG, C. M., LYMAN, C. M., ODOM, F. C. and WIDNER, C. *Federation Proc. Abstracts*, No. 3030 (1967).
290. OHKUMA, K., ADDICOTT, F. T., SMITH, O. E. and THIESSEN, W. E. *Tetrahedron Letters*, 2529 (1965).
291. OHKUMA, K., LYON, J. L., ADDICOTT, F. T. and SMITH, O. E. *Science*, **142**, 1592 (1963).
292. OLSON, R. E., BENTLEY, R., AIYAR, A. S., DIALAMEH, G. H., GOLD, P. H., RAMSEY, V. G. and SPRINGER, C. M. *J. Biol. Chem.*, **238**, PC3146 (1963).
293. OLSON, R. E. and DIALAMEH, G. H. *Biochem. Biophys. Res. Commun.*, **2**, 198 (1960).
294. OLSON, R. E., DIALAMEH, G. H. and BENTLEY, R. *Federation Proc.*, **19**, 220 (1960).
- 294a. OSHIMA, K. and URITANI, I., *Agr. Biol. Chem. (Japan)*, **9**, 1105 (1967).
295. PALEG, L. G. *Ann. Rev. Plant Physiol.*, L. Machlis and W. R. Briggs, eds., p. 291. Ann. Revs., Inc.; Palo Alto, California, Vol. 16 (1965).
296. PARK, R. B. and BONNER, J. *J. Biol. Chem.*, **233**, 340 (1958).
297. PARSON, W. W. and RUDNEY, H. *Proc. Natl. Acad. Sci.*, **51**, 444 (1964).
298. POLLARD, C. J., BONNER, J., HAAGEN-SMIT, A. J. and NIMMO, C. C. *Plant Physiol.*, **41**, 66 (1966).
299. POMINSKI, C. H., CASTILLION, L. E. and DECHARY, J. M. Removing the Glands of Cottonseed. *USDA, Yearbook of Agr.* 558 (1950-51).
300. POPIÁK, G. In the *Ciba Foundation Symposium on the Biosynthesis of Terpenes and Sterols*, p. 148. Boston: Little, Brown and Co. (1959).
301. POPIÁK, G. and CORNFORTH, J. W. In *Advances in Enzymology*, F. F. Nord, ed., p. 281. Interscience Pub., Vol. 22 (1960).
302. POPIÁK, G. and CORNFORTH, J. W. *Biochem. J.*, **101**, 553 (1966).
303. POPIÁK, G., CORNFORTH, J. W., CORNFORTH, R. H., RYHAGE, R. and GOODMAN, DEW. S. *J. Biol. Chem.*, **237**, 56 (1962).
304. POPIÁK, G., GOODMAN, DEW. S., CORNFORTH, J. W., CORNFORTH, R. H. and RYHAGE, R. *Biochem. Biophys. Res. Commun.*, **4**, 138 (1961).
305. POPIÁK, G., GOODMAN, DEW. S., CORNFORTH, J. W., CORNFORTH, R. H. and RYHAGE, R., *J. Biol. Chem.*, **236**, 1934 (1961).
306. PORSCH, F. and FARNOW, H. *Dragoco Report*, **3**, 54 (1962).
307. PRELOG, V. and MEIER, H. L. *Helv. Chim. Acta*, **33**, 1276 (1950).
308. PRELOG, V. and WURSCH, J. *Helv. Chim. Acta*, **34**, 859 (1951).
309. PRICE, G., M.S. Thesis, Oklahoma State University, August, 1967.
310. PRYDE, J. and WILLIAMS, R. T. *Biochem. J.*, **30**, 799 (1936).
311. PURCELL, A. E. *Arch. Biochem. Biophys.*, **105**, 606 (1964).
312. PURCELL, A. E., THOMPSON, G. A. and BONNER, J. *J. Biol. Chem.*, **234**, 1081 (1959).
313. REFSUM, S. *Acta Psychiat. Scand. Suppl.*, **38**, 1 (1946).
314. REGNIER, F. E., EISENBRAUN, E. J. and WALLER, G. R. *Phytochem.*, **6**, 1271 (1967).
315. REGNIER, F. E., WALLER, G. R. and EISENBRAUN, E. J. *Phytochem.*, **6**, 1281 (1967).

316. REGNIER, F. E., WALLER, G. R., EISENBRAUN, E. J. and AUDA, H. *Phytochem.*, **7**, 221 (1968).
317. REID, W. W. *Chem. and Ind. (London)*, 1489 (1961).
318. REID, W. W. *Biochem. J.*, **100**, 13P (1966).
319. REITSEMA, R. H. *J. Am. Pharm. Assoc., Sci. Ed.*, **47**, 267 (1958).
320. REITSEMA, R. H., CRAMER, F. J., SCULLY, N. J. and CHORNEY, W. J. *Pharm. Sci.*, **50**, 18 (1961).
321. REMMER, H. *Ann. Rev. Pharmacol.*, **5**, 405 (1965).
322. REUTER, G. *Abh. Deut. Akad. Wiss. Berlin, Kl. Chem., Geol. Biol.*, **617** (1966).
323. RICHARDS, J. H. and HENDRICKSON, J. B. *The Biosynthesis of Steroids, Terpenes and Acetogenins*. New York: W. A. Benjamin, Inc. (1964).
324. RITTERSDORF, W. *Angew. Chem.*, **77**, 432 (1965).
325. ROBINSON, D. R. and WEST, C. A. *Federation Proc.*, **26**, 454 (1967).
326. ROTH, L. M. and EISNER, T. *Ann. Rev. Ent.*, **7**, 107 (1962).
327. ROWLAND, R. L., LATIMER, P. H. and GILES, J. A. *J. Am. Chem. Soc.*, **78**, 4680 (1956).
328. RUDDAT, M., HEFTMAN, E. and LANG, A. *Arch. Biochem. Biophys.*, **110**, 496 (1965).
329. RUDDAT, M., HEFTMAN, E. and LANG, A. *Arch. Biochem. Biophys.*, **111**, 187 (1965).
330. RUDLEY, H., STEWART, P. R., MAJERUS, P. W. and VAGELOS, P. R. *J. Biol. Chem.*, **241**, 1226 (1966).
331. RUDNEY, H. *J. Biol. Chem.*, **227**, 363 (1957).
332. RUDNEY, H. In the *Ciba Foundation Symposium on the Biosynthesis of Terpenes and Sterols*, p. 75. Boston: Little, Brown and Co. (1959).
333. RUDNEY, H. and FERGUSON, J. J., JR. *J. Biol. Chem.*, **234**, 1076 (1959).
334. RUDNEY, H. and PARSON, W. W. *J. Biol. Chem.*, **238**, PC3137 (1963).
335. RUZICKA, L. *Experientia*, **9**, 357 (1953).
336. RUZICKA, L. In *Perspectives in Organic Chemistry*, A. Todd, ed., p. 265. New York: Interscience Publishers, Inc. (1956).
337. RUZICKA, L. *Pure Appl. Chem.*, **6**, 493 (1963).
338. SAKAN, T. *Kagaku no Ryoiki*, **14**, 237 (1960).
339. SAKAN, T., FUJINO, A., MURAI, F., BUTSUGAN, Y. and SUZUI, A. *Bull. Chem. Soc. (Japan)*, **32**, 315 (1959).
340. SAKAN, T., FUJINO, A., MURAI, F., SUZUI, A., BUTSUGAN, Y. and TERASHIMA, Y. *Bull. Chem. Soc. (Japan)*, **33**, 712 (1960).
341. SAKAN, T., ISOE, S., BE HYEON, S., KATSUMURA, R., MAEDA, T., WOLINSKY, J., DICKERSON, D., SLABAUGH, M. and NELSON, D. *Tetrahedron Letters*, 4097 (1965).
342. SAKAN, T., ISOE, S., BE HYEON, S., ONO, T. and TAKAGI, I. *Bull. Chem. Soc. (Japan)*, **37**, 1888 (1964).
343. SANDERMANN, W. In *Comparative Biochemistry III*, M. Florin and H. S. Mason, eds., p. 503. New York: Academic Press (1962).
344. SANDERMANN, W. In *Comparative Phytochemistry*, T. Swain, ed., p. 591. New York: Academic Press (1966).
345. SANDERMANN, W. and BRUNS, K. *Chem. Ber.*, **95**, 1863 (1962).
346. SANDERMANN, W. and BRUNS, K. *Naturwissenschaften*, **49**, 258 (1962).
347. SANDERMANN, W. and BRUNS, K. *Planta Medica*, **13**, 364 (1965).
348. SANDERMANN, W. and BRUNS, K. *Chem. Ber.*, **95**, 1863 (1967).
349. SANDERMANN, W. and SCHWEERS, W. *Tetrahedron Letters*, 257 (1962).
350. SANDERMANN, W. and SCHWEERS, W. *Tetrahedron Letters*, 259 (1962).
351. SANDERMANN, W. and SIMATUPANG, M. H. *Chem. Ber.*, **26**, 2182 (1963).
352. SCHANKER, L. S. *Ann. Rev. Pharmacol.*, **1**, 29 (1961).
353. SCHLESINGER, M. J. and COON, M. J. *J. Biol. Chem.*, **236**, 2421 (1961).
354. SCHMIEDERBERG, O. and MEYER, H. *Hoppe-Seyl. Z.*, **3**, 422 (1879).
355. SCHNEOUR, E. A. *Biochim. Biophys. Acta*, **65**, 510 (1962).
356. SEUBERT, W. and FASS, E. *Biochem. Z.*, **341**, 23 (1964).
357. SEUBERT, W., FASS, E. and REMBERGER, U. *Biochem. Z.*, **338**, 265 (1963).
358. SHAH, D. H., CLELAND, W. W., PORTER, J. W. *J. Biol. Chem.*, **240**, 1946 (1965).
359. SHANTZ, E. M. *Ann. Rev. Plant Physiol.*, L. Machlis, W. R. Briggs and R. B. Park, eds., p. 409. Ann. Revs., Inc.: Palo Alto, California (1966).
360. SIMORNEN, J. L. *The Terpenes*, Vol. I, pp. 28, 230. Mass.: Cambridge University Press (1947).
361. SKEGGS, H. R., WRIGHT, L. E., CRESSON, E. L., MACRAE, G. D. E., HOFFMAN, C. H., WOLF, D. E. and FOLKERS, K. *J. Bacteriol.*, **72**, 519 (1956).

362. SMITH, F. *Nature*, **192**, 888 (1961).
363. SMITH, F. H. In *Proceedings Cottonseed Quality Research Conference*, p. 7. Mississippi Agricultural Experiment Station, Greenville, Mississippi (1962).
364. SOUCEK, M. *Coll. Czech. Chem. Comm.*, **27**, 2929 (1962).
365. SOUCEK, M. and VRKOC, J. *IUPAC 4th International Symposium on the Chemistry of Natural Products*, Stockholm, Sweden, June 26–July 2, Abstract Book, p. 145 (1966).
366. SRIDHARA, S. and BHAT, J. V. *Life Sci.*, **4**, 167 (1965).
367. STANLEY, R. G. *Nature*, **182**, 738 (1958).
368. STEELE, W. J. and GURIN, S. J. *Biol. Chem.*, **235**, 2778 (1960).
369. STEINBERG, D., AVIGAN, J., MIZE, C. E. and BAXTER, J. H. *Biochem. Biophys. Res. Commun.*, **19**, 412 (1965).
370. STEINBERG, D., AVIGAN, J., MIZE, C. E., BAXTER, J. H., CAMMERMEYER, J., FALES, H. M. and HIGHET, P. F. *J. Lipid Res.*, **7**, 684 (1966).
371. STEVENSON, J., HEMMING, F. W. and MORTON, R. A. *Biochem. J.*, **88**, 52 (1963).
372. STONE, K. H., WELLBURN, A. R., HEMMING, F. W. and PENNOCK, J. F. *Biochem. J.*, **102**, 325 (1967).
373. STUMPF, P. K. and JAMES, A. T. *Biochim. Biophys. Acta*, **70**, 20 (1963).
374. SUHADOLNIK, R. J. Personal communication.
375. SUKHOV, G. V. *Radioisotopes in Scientific Research*, R. E. Extermann, ed., p. 535. London: Pergamon Press (1958).
376. SWAIN, T. (Ed.) *Chemical Plant Taxonomy*. London: Academic Press (1963).
377. TAMURA, S., SAKURAI, A., KAINUMA, K. and TAKAI, M. *Agr. Biol. Chem. (Tokyo)*, **29**, 216 (1965).
378. TAVORMINA, P. A. and GIBBS, M. H. *J. Am. Chem. Soc.*, **78**, 6210 (1956).
379. TAVORMINA, P. A., GIBBS, H. M. and HUFF, J. W. *J. Am. Chem. Soc.*, **78**, 4498 (1956).
380. TAYLOR, W. I. *Science*, **153**, 954 (1966).
381. TCHEN, T. T. *J. Biol. Chem.*, **233**, 1100 (1958).
382. TEAS, H. J. and BANDURSKI, R. *J. Am. Chem. Soc.*, **78**, 3549 (1956).
383. TEAS, H. J. and BONNER, J. *Rev. Gen. Caoutchouc*, **37**, 1143 (1960).
384. THEORELL, H. and BONNICHSEN, R. *Acta Chem. Scand.*, **5**, 1105 (1951).
385. THOMAS, A. F. and WILLHALM, B. *Tetrahedron Letters*, 3775 (1964).
386. THOMAS, R. *Tetrahedron Letters*, 544 (1961).
387. THOMPSON, G. A., PURCELL, A. E. and BONNER, J. *Plant Physiol.*, **35**, 678 (1960).
388. THORNE, K. J. I. and KODICEK, E. *Biochem. J.*, **99**, 127 (1966).
389. TODD, N. B. *J. Heredity*, **53**, 54 (1962).
390. TRUDGILL, P. W., DUBUS, R. and GUNSALUS, I. C. *J. Biol. Chem.*, **241**, 1194 (1966).
391. TRUDGILL, P. W., DUBUS, R. and GUNSALUS, I. C. *J. Biol. Chem.*, **241**, 4288 (1966).
392. TSCHESCHE, R. and BRASSAT, B. *Z. Naturforsch.*, **20b**, 707 (1965).
393. TSCHESCHE, R. and HULPKE, H. *Z. Naturforsch.*, **21b**, 494 (1966).
394. TSCHESCHE, R. and LILIENWEISS, G. *Z. Naturforsch.*, **19b**, 265 (1964).
395. TSCHESCHE, R. and SNATZKE, G. *Ann. Chem.*, **636**, 105 (1960).
396. TSO, T. C. and JEFFREY, R. N. *Arch. Biochem. Biophys.*, **92**, 253 (1961); see also preceding papers in this series.
397. VALENZULA, P., BEYTIA, E., CORI, O. and YUDELEVICH, A. *Arch. Biochem. Biophys.*, **113**, 536 (1966).
398. VALENZULA, P., CORI, O. and YUDELEVICH, A. *Phytochem.*, **5**, 1005 (1966).
- 398a. VALENZULA, P., BEYTIA, E., CORI, O. and YUDELEVICH, A., *Arch. Biochem. Biophys.*, **113**, 536 (1966).
399. VAN TAMELEN, E. E., WILLETT, J. D., CLAYTON, R. B. and LORD, K. E. *J. Am. Chem. Soc.*, **88**, 4952 (1966).
400. VARMA, T. N. R. and CHICHESTER, C. O. *Arch. Biochem. Biophys.*, **96**, 419 (1962).
401. VERBISCAR, A. J., CRAGG, G., GEISSMAN, T. A. and PHINNEY, B. O. *Phytochem.*, **6**, 807 (1967).
402. VILLANCUVA, V. R., BARBIER, M. and LEDERER, E. *Bull. Soc. Chim.*, 1423 (1964).
403. VRKOC, J. and LOOMIS, W. D. Abstract from American Society Plant Physiology Meeting (Western Section) held in Los Angeles, Calif., June 1967.
404. VRKOC, J., SOUCEK, M. and SORM, F. *4th International Symposium on the Chemistry of Natural Products*, Stockholm, Sweden, June 26–July 2, Abstract, p. 141 (1966).
405. WALLACH, O. *Ann.*, **239**, 1 (1887).
406. WALLER, G. R. Unpublished results.

407. WALLER, G. R. *Nature*, **207**, 1389 (1965).
408. WALLER, G. R., FROST, G. M., BURLESON, D., BRANNON, D. and ZALKOW, L. H. *Phytochem.*, **7**, 213 (1968).
409. WALLER, G. R., TANG, M. S., SCOTT, M. R., GOLDBERG, F. J., MAYES, J. S. and AUDA, H. *Plant Physiol.*, **40**, 803 (1965).
410. WEEDON, B. C. L. In *Chem. Biochem. Plant Pigments*, T. W. Goodwin, ed., p. 75. New York: Academic Press (1965).
411. WEISSMAN, G. In *Comparative Phytochemistry*, T. Swain, ed., p. 97. New York: Academic Press (1966).
412. WELLBURN, A. and HEMMING, F. W. *Phytochem.*, **5**, 969 (1966).
413. WELLBURN, A. R., STEVENSON, J., HEMMING, F. W. and MORTON, R. A. *Biochem. J.*, **102**, 313 (1967).
414. WELLS, L. W., SCHELBE, W. J. and PORTER, J. W. *Federation Proc.*, **23**, 426 (1964).
415. WENKERT, E. *J. Am. Chem. Soc.*, **84**, 98 (1962).
416. WEST, C. A. Personal communication.
417. WEYGAND, F. and FLOSS, H. G. *Angew. Chem. Internat. Ed.*, **2**, 243 (1963).
418. WILLIAMS, R. T. *Biochem. J.*, **34**, 690 (1940).
419. WILLIAMS, R. T. *Biochem. J.*, **32**, 1849 (1938).
420. WILLIAMS, R. T. *Detoxication Mechanisms*, p. 519. New York: J. Wiley and Sons, Inc. (1959).
421. WILLIAMSON, I. P. and KEKWICK, R. G. O. *Biochem. J.*, **88**, 18P (1963).
422. WODE, A. P., WILKINSON, G. S., DEAN, F. M. and PRICE, A. W. *Biochem. J.*, **101**, 727 (1966).
423. WOLSTENHOLME, G. E. W. and O'CONNOR, M. (Eds.). *Ciba Foundation Symposium on the Biosynthesis of Terpenes and Steroids*. Boston: Little, Brown and Co. (1959).
424. WOLSTENHOLME, G. E. W. and O'CONNOR, M. (Eds.). *Ciba Foundation Symposium on Quinones in Electron Transport*. Churchill, London (1961).
425. WRIGHT, L. D. *Ann. Rev. Biochem.*, **30**, 525 (1961).
426. WRIGHT, L. D., CLELAND, M., DUTTA, B. N. and NORTON, J. S. *J. Am. Chem. Soc.*, **79**, 6572 (1957).
427. WRIGHT, S. E. *University of Queensland Papers*, **1**, No. 25 (from ref. 420).
428. YAMAMOTO, H. Y., CHICHESTER, C. O. and NAKAYAMA, T. O. M. *Arch. Biochem. Biophys.*, **96**, 645 (1962).
429. YEOWELL, D. A. and SCHMID, H. *Experientia*, **20**, 250 (1964).